

# Differential pressure gauge Model 712.15.160, copper alloy Model 732.15.160, stainless steel version

WIKA data sheet PM 07.30



for further approvals  
see page 3

## Cryo Gauge

### Applications

- Level measurements in closed tanks, particularly in cryotechnology
- Filter monitoring
- Pump monitoring and control
- For gaseous and liquid media that are not highly viscous or crystallising and have no suspended solids

### Special features

- Differential pressure measuring ranges from 0 ... 40 mbar to 0 ... 4,000 mbar
- High working pressure (static pressure) of 50 bar
- Overpressure safety either side up to 50 bar
- Scalable measuring ranges (turndown to max. 1 : 3.5)
- Option: Remote data transfer module intelliMETRY
- Option: Compact valve manifold with working pressure indication

### Description

These high-quality gauges are characterised by their compact and robust design and are primarily used for level measurement on liquid gas tanks.

With only 6 different measuring cells all usual tank sizes in cryotechnology are covered. As a result of the large measuring range overlap of the respective measuring cells, the gauge installed on the tank can be adjusted to match a whole variety of gases such as Ar, O<sub>2</sub>, N<sub>2</sub> or CO<sub>2</sub>, with a full-scale deflection over a complete 270 degree sweep. The span adjustment is accessible from outside and does not affect the zero point. The mechanical display and the optional electrical output signal are calibrated simultaneously and easily.

An optional valve manifold for flange mounting with working pressure indication makes the central measurement of both level and working pressure possible in the one instrument.

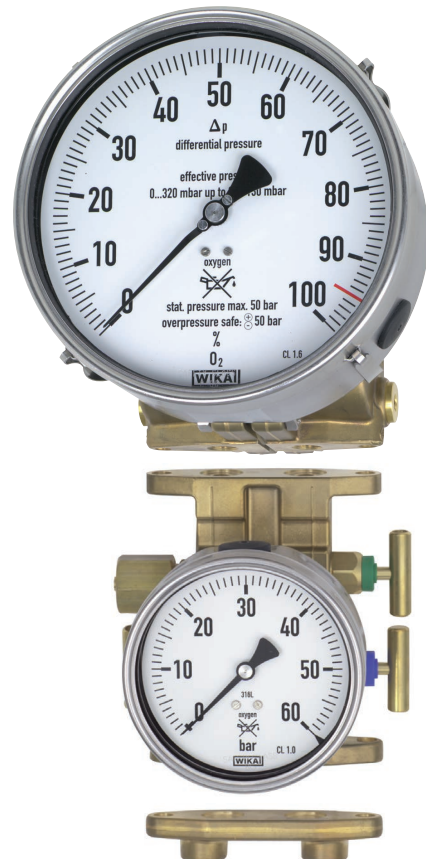

**Fig. top: Differential pressure gauge model 712.15.160**

**Fig. centre: Option manifold with working pressure indication**

**Fig. bottom: Option adapter for flange mounting**

The level indicator can be supplied with an optional, integrated 4 ... 20 mA, 2-wire transmitter. Switch contacts for level and working pressure, as well as a transmitter for the working pressure can be retrofitted on site. Versions with transmitters can be expanded with the Remote data transfer module intelliMETRY. The intelliMETRY sends measured data to an online data centre using GSM technology.

The standard centre distance of 37 mm between the process connections can be adapted to a custom centre distance of 31 mm or 54 mm using adapters for flange mounting.

## Design and operating principle

Pressures  $p_1$  and  $p_2$  act on the media chambers  $\oplus$  and  $\ominus$ , which are separated by an elastic diaphragm (1).

The differential pressure ( $\Delta p = p_1 - p_2$ ) leads to an axial deflection of the diaphragm against the measuring range spring (2).

The deflection, which is proportional to the differential pressure, is transmitted to the movement (5) in the indicating case (4) via a pressure-tight and low friction lever mechanism (3).

Overpressure safety is provided by metal bolsters (6) resting against the elastic diaphragm.

## Illustration of the principle

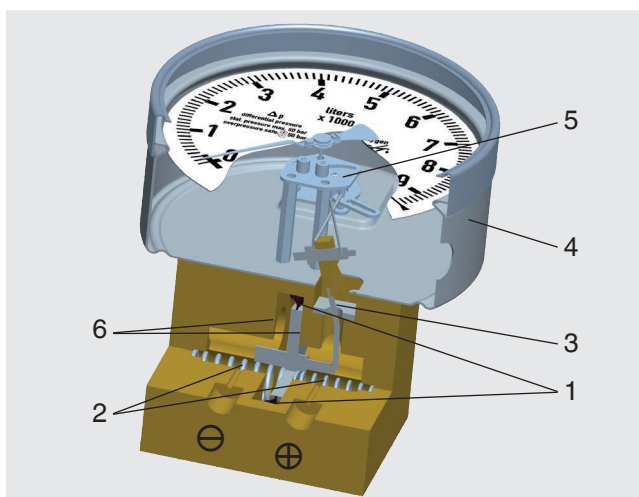

Mounting according to affixed symbols,  $\oplus$  high pressure and  $\ominus$  low pressure

## Standard version

### Differential pressure gauge

Model 712.15.160

Model 732.15.160



Specifications	
Nominal size	NS 160 (level indicator)
Accuracy class	2.5 (option: Class 1.6 or class 1.0)
Scale ranges (see also span adjustment)	<ul style="list-style-type: none"> <li>■ Measuring cell 140 mbar: Setting range 0 ... 40 mbar to 0 ... 140 mbar</li> <li>■ Measuring cell 280 mbar: Setting range 0 ... 80 mbar to 0 ... 280 mbar</li> <li>■ Measuring cell 560 mbar: Setting range 0 ... 160 mbar to 0 ... 560 mbar</li> <li>■ Measuring cell 1,130 mbar: Setting range 0 ... 320 mbar to 0 ... 1,130 mbar</li> <li>■ Measuring cell 2,300 mbar: Setting range 0 ... 650 mbar to 0 ... 2,300 mbar</li> <li>■ Measuring cell 4,000 mbar: Setting range 0 ... 1,150 mbar to 0 ... 4,000 mbar</li> </ul>
Max. working pressure (static pressure)	50 bar
Overpressure safety	either side up to 50 bar
Permissible ambient temperatures	-40 ... +80 °C, -40 ... +60 °C with oxygen
Permissible medium temperatures	-40 ... +80 °C, -40 ... +60 °C with oxygen
Ingress protection	IP 65 per EN 60529 / IEC 60529
Process connections (wetted)	2 x G 1/4 (optional: 2 x 1/4 NPT), female, lower mount (LM), centre distance 37 mm
Option with adapter	see page 5
Measuring cell flanges (wetted)	Model 712.15: Copper alloy CW614N (CuZn39Pb3) Model 732.15: Stainless steel 316L
Pressure elements (wetted)	Compression spring, stainless steel 1.4310 Separating diaphragm, NBR Transmission parts, stainless steel 1.4301 and 1.4305
Movement	Wear parts stainless steel
Dial	White aluminium (see section "Scale designs")
Pointer	Adjustable pointer, black aluminium
Zero adjustment	By means of adjustable pointer
Case / slip-on bezel	Stainless steel, with clip fasteners
Window	Polycarbonate (PC)



## Option

Valve manifold (wetted)  
with mounted working pressure gauge

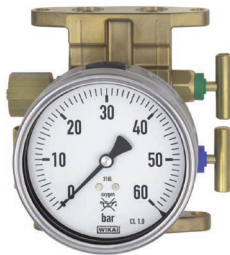

Specifications	
Valves	2 x shut-off valve, 1 x pressure compensating valve
Test connection	M20 x 1.5 with sealing cap (DIN 16287-A)
Valve body	Model 712.15: Copper alloy CW614N (CuZn39Pb3); model 732.15: Stainless steel 316L
Spindle with conical nipple	Model 712.15: Copper alloy; model 732.15: Stainless steel 316L
Packing/sealing	NBR/PTFE
	With the valve fully-opened, the spindle area is isolated from the process by a metallic seal, the packing is not loaded and the spindle thread is not in contact with the measured media.
<b>Working pressure gauge</b>	
Standard	Model 212.20.100, wetted parts Cu-alloy (for specifications and design details see data sheet PM 02.01)
Option	Model 232.50.100, wetted parts stainless steel (for specifications and design details see data sheet PM 02.02)
Option	Model 232.30.100, safety version, wetted parts stainless steel (for specifications and design details see data sheet PM 02.04)

With a single order, all parts necessary for the fitting to the differential pressure gauge are included in the delivery:  
4 x hexagon screws M8 x 16, 2 x O-ring seal

## Dimensions in mm

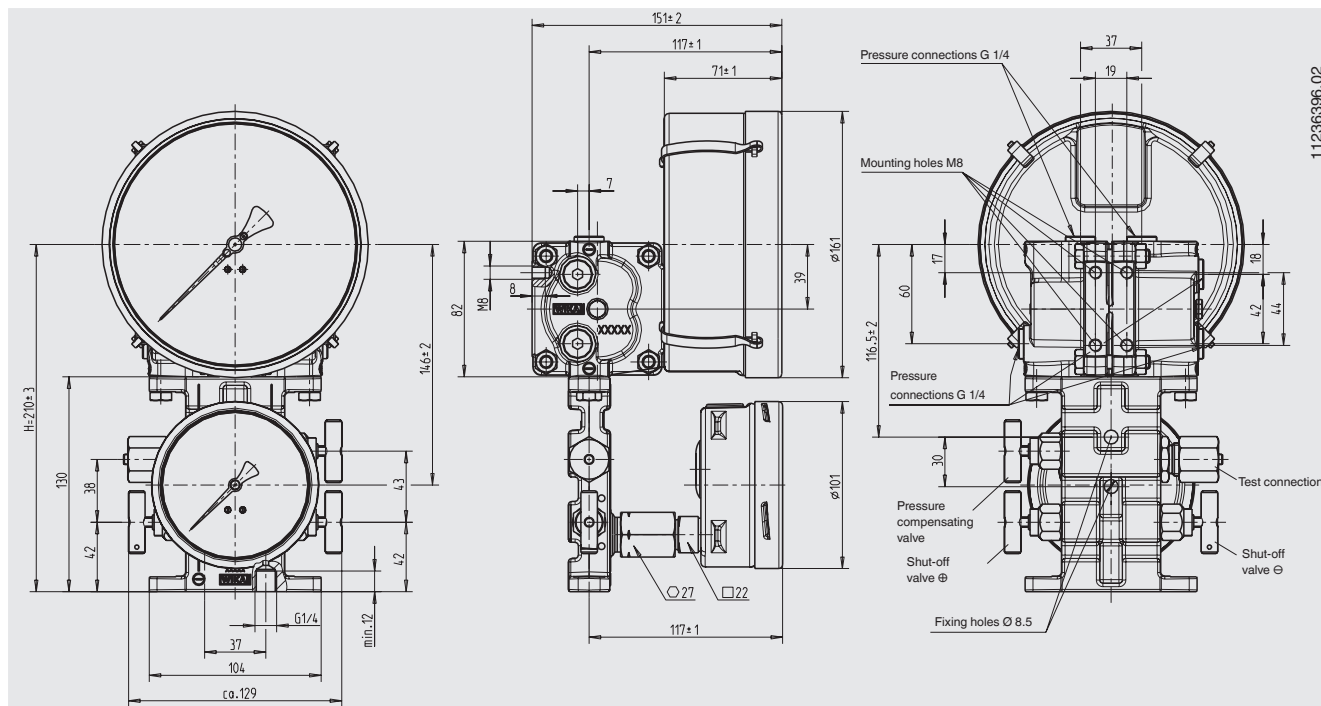

Drawing with mounted adapter (centre distance 54 mm)

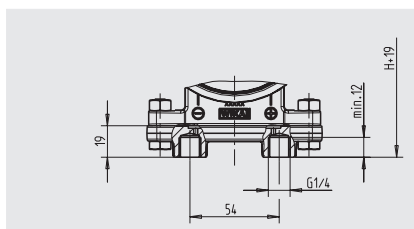

## Option

### Adapter for process connection



The adapters can be flange mounted either directly to the differential pressure gauge or to the valve manifold.

Specifications	
Material	Model 712.15: Cu-alloy CW614N (CuZn39Pb3); model 732.15: Stainless steel 316L
Process connections (wetted)	2 x G 1/4, female, centre distance 31 mm or 54 mm or 2 x 1/4 MPT, female, centre distance 31 mm or 54 mm

With a single order, all parts necessary for the fitting to the differential pressure gauge or to the valve manifold are included in the delivery:

2 x hexagon screws M8 x 16 , 2 x hexagon screws M8 x 28, 2 x nut M8 and 2 x O-ring seal

## Option

### Transmitter for level

Standard version model 891.44  
Ex version model 892.44

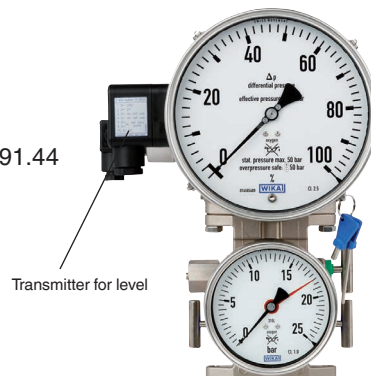

WIKA differential pressure gauges with an integrated model 89x.44 transmitter combine all the advantages of an on-site mechanical display with the demands modern industry makes for electrical signal transmission for the acquisition of measured values.

The transmitter is integrated into the case of the level indicator. The measuring span (electrical output signal) is set automatically by the mechanical display, i.e. the scale of 270 angular degrees corresponds to 4 ... 20 mA. With multiple scales or interchangeable attachable scales (option), the output signal of 4 ... 20 mA corresponding to each can be stored in a microprocessor. The output signal can be changed over to the desired gas type by rotating the optional BCD switch (accessible through a sealing cap on the left side of the case) using a screwdriver.

Specifications		Models 891.44 and 892.44 (Ex version)
Power supply $UB$	DC V	$12 < UB \leq 30$ (min. 14 with Ex version)
Influence of power supply	% of full scale/10 V	$\leq 0.1$
Permissible residual ripple	% ss	$\leq 10$
Output signal		4 ... 20 mA, 2-wire
Permissible max. load $RA$		for non-Ex versions, model 891.44: $RA \leq (UB - 12 \text{ V}) / 0.02 \text{ A}$ with $RA$ in Ohm and $UB$ in Volt for Ex versions, model 892.44: $RA \leq (UB - 14 \text{ V}) / 0.02 \text{ A}$ with $RA$ in Ohm and $UB$ in Volt
Effect of load	% of full scale value	$\leq 0.1$
Adjustability		
Zero point, electrical		Adjustment of the zero point through brief bridging of terminals 5 and 6 or using the "scale selection switch" option, selectable via button <sup>1)</sup>
Scale selection		4 scales selectable via BCD switch
Linear error	% of span	$\leq 1.0 \%$ (terminal method)
Permissible		
ambient temperatures	°C	-40 ... +80, -40 ... +60 with oxygen
Compensated temperature range	°C	-40 ... +80
Temperature coefficients in the compensated temperature range		
Mean $TC$ zero point	% of span/10 K	$\leq 0.3$
Mean $TC$ span	% of span/10 K	$\leq 0.3$

1) Only possible within 30 seconds of connecting the supply voltage

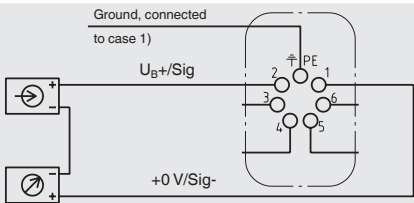
Further specifications		Models 891.44 and 892.44 (Ex version)
<b>Safety-related maximum values</b>		Ex version
■ Power supply $U_i$	DC V	14 ... max. 30
■ Short-circuit current $I_i$	mA	max. 100
■ Power $P_i$	W	max. 1
■ Internal capacitance $C_i$	nF	12
■ Internal inductance $L_i$	mH	negligible
<b>Medium temperature</b>	°C	-40 ... +80, -40 ... +60 with oxygen
<b>Ambient temperature</b>	°C	-40 ... +60 (T6)
<b>Electrical connection</b>		Angular connector, 180° rotatable, wire protection, cable gland M20 x 1.5, incl. strain relief, connection cable: Outer diameter 7 ... 13 mm, conductor cross-section 0.14 ... 1.5 mm <sup>2</sup> , temperature resistance up to 60 °C
<b>Wiring protection</b>		Protection against reverse polarity and overvoltage
<b>Ingress protection</b>		IP 65 per EN 60529 / IEC 60529
<b>Wiring details, 2-wire</b>		 <p>1) This connection must not be used for equipotential bonding. The instrument must be incorporated in the equipotential bonding via the process connection.</p>

## Option

### Transmitter for working pressure

Standard version model A-10  
or Ex version model IS-20

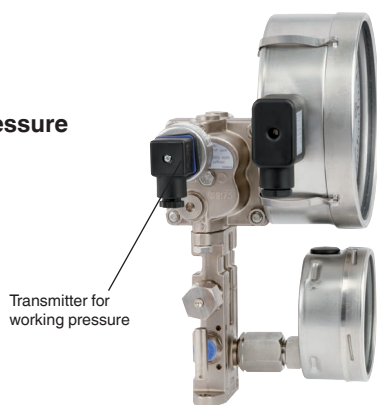

The transmitters for the working pressure are screwed in sideways, on the left side of the minus media chamber and can, if necessary, be retrofitted on site.

Pressure connection of the transmitter:  
Male thread G 1/4

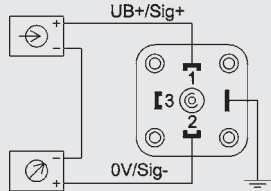
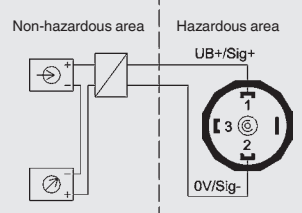

Specifications		A-10	IS-20
<b>Data sheet</b>		PE 81.60	PE 81.50
<b>Design</b>		standard	intrinsically safe
<b>Measuring ranges</b>	bar	0 ... 2.5 to 0 ... 60	0 ... 2.5 to 0 ... 60
<b>Outputs</b>	mA	4 ... 20	4 ... 20 (isolated barrier)
<b>Medium temperature</b>	°C	-30 ... +100	-20 ... +80
<b>Ambient temperature</b>	°C	-30 ... +80	-20 ... +80
<b>Wetted parts</b>		Stainless steel	Stainless steel
<b>Power supply <math>U_B</math></b>	DC	$10\text{ V} < U_B \leq 30\text{ V}$	$10\text{ V} < U_B \leq 30\text{ V}$
<b>Permissible max. load <math>R_A</math></b>	Ohm	$R_A \leq (U_B - 8\text{ V}) / 0.02\text{ A}$	$R_A \leq (U_B - 10\text{ V}) / 0.02\text{ A}$
<b>Accuracy</b>			
Best fit straight line, BFSL	% of span	$\leq 0.5$	$\leq 0.25$
<b>Compensated temperature range</b>	°C	0 ... +80 °C	0 ... +80 °C
<b>Designation of terminal connectors, 2-wire</b>			

## Option

### Remote data transfer module intelliMETRY for versions with transmitter

Standard version model 908.01

The retrofittable intelliMETRY module expands the local measured value registration by the possibilities of modern Remote data transfer.

Current measured values for level and working pressure are transmitted via GSM standard to an online data centre.



The online data centre receives the data packages and offers extensive and user-defined possibilities for data processing. The voltage supply of the intelliMETRY can be provided by an available current loop or by an external power supply. A battery module is available as an option.

Function	Description
<b>Data transfer measured values</b>	Radio standard GSM. Status messages are sent either in GPRS or in SMS mode. As standard, measured values are transmitted in GPRS mode every hour, in SMS mode once or twice a day (routine messages).
<b>User-defined alarms</b>	Alarm message when a value exceeds or drops below a user-defined limit Examples: "Level < 30 %" or "Working pressure too high!"
<b>Consumption-related warning messages</b>	Warning message signalling an excessive consumption per a defined time interval. Example: "Level drops by more than 10 % in comparison with the last status message"
<b>Sampling rate / monitoring interval</b>	With voltage supply in network operation, all process parameters are monitored once per minute. In battery operation they are monitored at intervals of 15 minutes.
<b>Data loggers</b>	With the data logger activated, all measured values are saved at intervals of 15 minutes and are then transmitted to the online data centre after a maximum of 12 hours.

### Online data centre

The online data centre is available at <https://www.global-datacenter.de> any time.

After entering the personal access data, intelliMETRY modules can be monitored and managed there. The online data centre allows for the central configuration of all measuring points. In this way, subsequent setting changes can be carried out easily and clearly.

Further details and user instructions are available at the online data centre.

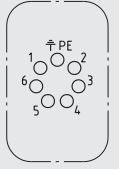
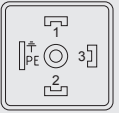
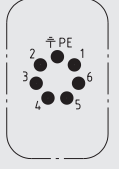
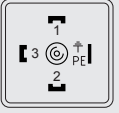
Specifications	RDT module intelliMETRY
Required GSM level	≥ 30 %
Power supply $U_B$	DC 24 V ± 5 % Pmax: 5 W M12 x 1 connector, 5-pin, B-coding per IEC 61076-2-101 
Permissible residual ripple	≤ 10 % ss
Signal input level	4 ... 20 mA, 2-wire cable with 7-pin angular connector 
Signal input working pressure	4 ... 20 mA, 2-wire Cable with 4-pin angular connector 
Signal output level	4 ... 20 mA, 3-wire 7-pin connector on case 
Signal output working pressure	4 ... 20 mA, 3-wire 4-pin connector at the case 
Permissible temperature ranges	Storage: -40 ... +70 °C Ambient: -20 ... +70 °C
Permissible humidity	0 ... 95 % r. h. (non-condensing)
Ingress protection	IP 65 per EN 60529 / IEC 60529
Dimensions	W x H x D: approx. 80 x 125 x 57 mm (without antenna)
Weight	approx. 0.9 kg
CE conformity	
Directives	2004/108/EC (EMC) 1999/005/EC (R&TTE)

Specifications	Battery module
Voltage generation	Lithium metal battery per UN3090/ UN3091
Output voltage	DC 3.6 V
Battery capacity	19 Ah
Electrical connection	M12 x 1 mating connector, 5-pin, B-coding per IEC 61076-2-101 
Service life	≥ 1 year with 4 times sensor scanning/h and 2 SMS/day
Permissible temperature ranges	Storage: -40 ... +70 °C Ambient: -20 ... +70 °C
Permissible humidity	0 ... 95 % r. h. (non-condensing)
Ingress protection	IP 65 per EN 60529 / IEC 60529
Dimensions	W x H x D: approx. 80 x 75 x 57 mm
Weight	approx. 0.5 kg
CE conformity	
Directives	2004/108/EC (EMC)





## Option

### Switch contacts

for level indicators and/or working pressure

A modular system of electromechanical and electronic switch contacts with plug connection, also suitable for retrofitting on site, can be fitted both to the level indicator and to the working pressure indicator. They consist of self-contained units, which can be fitted to any pointer pressure gauge within a few minutes. The connection to the instrument pointer is made by means of a special yoke so that a carrier pin at the pointer itself is not needed. The set value pointer of the installed switch contacts are adjusted, from the outside, to the value at which the switching operation is to take place, using the adjustment lock with a separate or integral key. A coupler connector, an M3 x 20 centring screw and a seal are included in the delivery.

Selectable are the following single and double contact models built into a self-contained unit

- Model 828 <sup>1)</sup>, magnetic snap-action contact
- Model 838 <sup>1)</sup>, inductive contact gauge

### Switching functions

The following applies, as a general rule, to the contact

functions of the model 828 <sup>1)</sup> magnetic snap-action contacts in connection with our standard settings:

**Index 1** according to the contact type no. means:

**Contact closes** the circuit when the set point is exceeded

**Index 2** according to the contact type no. means:

**Contact opens** the circuit when the set point is exceeded

**Index 3** according to the contact type no. means:

When the set value is exceeded, one circuit is opened and one circuit is closed **simultaneously** (change-over contact)

The following applies, as a general rule, to the contact functions of the model 838 <sup>1)</sup> inductive contacts in connection with our standard settings:

**Index 1** according to the contact type no. means:

**Contact closes** the control circuit when the set point is exceeded (flag disengages **from control head**)

**Index 2** according to the contact type no. means:

**Contact opens** the control circuit when the set point is exceeded (flag engages **with control head**)

The switching functions are based on a clockwise rotational motion of the instrument pointer.

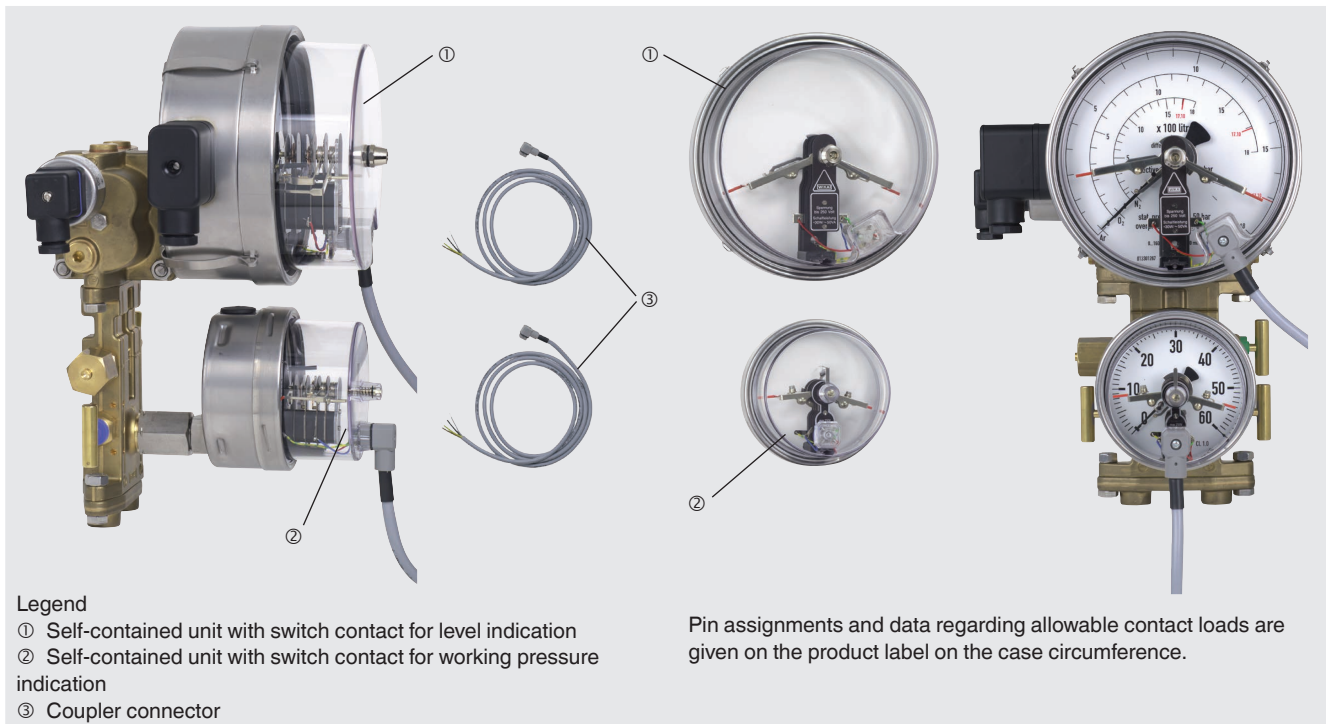

For further specifications and design details see data sheet AC 08.01 <sup>1)</sup>

<sup>1)</sup> Specifications given in data sheet AC 08.01 for Model 821 correspond to model 828 (built into a self-contained unit) Model 831 correspond to model 838 (built into a self-contained unit)

