



PT3E-0499

Explosion-Proof Calorimeter
OHC-800
Operating Manual

RIKEN KEIKI Co., Ltd.

2-7-6 Azusawa, Itabashi-ku, Tokyo, 174-8744, Japan

Phone : +81-3-3966-1113

Fax : +81-3-3558-9110



E-mail : intdept@rikenkeiki.co.jp

Web site : <http://www.rikenkeiki.co.jp/>

Thank you for choosing our explosion-proof calorimeter OHC-800.

This manual explains how to use the calorimeter and its specifications. It contains information required for using the calorimeter properly. Not only the first-time users but also the users who have already used the product must read and understand the operating manual to enhance the knowledge and experience before using the calorimeter.

Throughout this manual, the following indications are used to ensure safe and effective work.

 DANGER	This message indicates that improper handling may cause death or serious damage on health or assets.
 WARNING	This message indicates that improper handling may cause serious damage on health or assets.
 CAUTION	This message indicates that improper handling may cause minor damage on health or assets.
NOTE	This message indicates advice on handling.

Note) MODBUS is registered trademarks of Schneider automation inc.

<Contents>

1. Important Notices on Safety	4
1-1. Danger cases	4
1-2. Warning cases	5
1-3. Precautions	6
1-4. Method of confirmation for Standards and Explosion proof specification	6
1-5. Information about explosion-proof performance (Japanese explosion-proof spec.)	7
1-5-1. About OHC-800	7
1-5-2. Technical data	7
1-5-3. System configuration for use in hazardous location	8
1-6. Information about explosion-proof performance (Overseas explosion-proof spec.)	9
1-6-1. About OHC-800	9
1-6-2. Technical data	9
1-6-3. System configuration for use in hazardous location	10
1-6-4. Notice on safety	11
2. Product Components	14
2-1. Purpose of use and features of this product	14
2-2. Main unit and standard accessories	15
2-3. Names of internal product components	16
2-4. Names and functions of display	17
3. How to Install Calorimeter	18
3-1. Precautions on installation site	18
3-2. Installation procedure and required maintenance space	19
3-3. How to connect wire	20
3-3-1. Description of terminal block	20
3-3-2. Recommended cables	22
3-3-3. How to lead in and connect cables	23
3-3-4. Protective grounding	25
3-3-5. Precautions on electrical work	26
3-4. How to tube	29
3-4-1. Sampling device	29
3-4-2. Recommended external tubing system	30
3-4-3. Precautions on tubing work	31
4. How to Operate in MEASURING MODE	32
4-1. From display just after power-on to measurement start	32
4-2. How to switch display screens	34
4-3. Switching to other mode	35
4-4. Self-diagnostic function	36
4-5. Operations of contacts, display, and signal output after recovery to normal state	37
5. How to Operate in Check Mode	38
5-1. Menu items of CHECK MODE	39
5-2. Items and details	40
5-2-1. Check of optical sensor unit state (OPTICAL SENSOR UNIT CONDITION)	40
5-2-2. Check of sonic sensor unit state (SONIC SENSOR UNIT CONDITION)	41
5-2-3. Check of main controller state (MAIN CONTROLLER CONDITION)	41
5-2-4. Check of measuring conditions for calorific value (CALORIFIC VALUE PARAMETER)	42
5-2-5. Check of measuring conditions for density (DENSITY PARAMETER)	42
5-2-6. Check of 4 - 20 mA settings (4 - 20 mA PARAMETER)	42
5-2-7. Check of pressure sensor output (PRESSURE SENSOR READINGS)	43
5-2-8. Check of temperature sensor output (TEMPERATURE SENSOR READINGS)	43
5-2-9. Check of calorific value calculation settings (CALCULATION FACTOR (CALORIFIC VALUE))	44
5-2-10. Check of density calculation settings (CALCULATION FACTOR (DENSITY))	44
5-2-11. Check of Opt-Sonic calculation process (OPT-SONIC READINGS)	45
5-2-12. Check of display and contact settings (DISP. & CONTACT PARAMETER)	45
5-2-13. Latching reset for display and contact (LATCHING RESET (DISP. & CONTACT))	46
6. How to Operate in SETUP MODE	47
6-1. SETUP MODE items	49
6-2. Items and details	50
6-2-1. Setting of calorific value calculation conditions (CALCULATION FACTOR (CALORIFIC VALUE))	50
6-2-2. Setting of density calculation conditions (CALCULATION FACTOR (DENSITY))	51

6-2-3. 4 – 20 mA condition settings (4 – 20 mA SETTINGS).....	52
6-2-4. 4 – 20 mA output adjustment (4 – 20 mA ADJUSTMENT).....	53
6-2-5. 4 – 20 mA output test (4 – 20 mA TEST)	54
6-2-6. Reference calibration (REF. CALIBRATION)	55
6-2-7. Offset (OFFSET ADJUSTMENT).....	56
6-2-8. Display and contact operation settings (DISP. & CONTACT SETTINGS).....	57
6-2-9. LCD display settings (LCD DISPLAY SETTINGS).....	58
6-2-10. RS-485 (MODBUS) communication settings (RS-485(MODBUS) SETTINGS).....	59
6-2-11. Change of energized contact settings (CONTACT SETTINGS).....	60
6-2-12. Check the contact operation (CONTACT TEST).....	60
6-2-13. Password change (PASSWORD SETUP (SETUP MODE))	61
6-2-14. Log data download (IrDA COMMUNICATION)	61
7. Maintenance	62
7-1. Maintenance intervals and items	62
7-1-1. Daily maintenance	62
7-1-2. Monthly regular maintenance	63
7-1-3. Biannual regular maintenance	64
7-2. Recommended regular replacement parts	65
8. Storage, Relocation, and Disposal	66
8-1. Procedures to store the calorimeter or leave it for a long time	66
8-2. Procedures to relocate the calorimeter or use it again	66
8-3. Disposal of products	67
9. Troubleshooting.....	68
9-1. <FAILURE>	68
9-2. <OUT OF SPECIFICATION>.....	71
9-3. <MAINTENANCE REQUIRED>	73
9-4. <FUNCTION CHECK>	74
9-5. CAUTION screen	75
9-6. Others.....	76
9-7. If not applicable to display	77
10. Product Specifications	78
10-1. Product specifications.....	78
10-2. Principle of this product	79
10-2-1. Opt-Sonic calculation (calorific value).....	79
10-2-2. Opt-Sonic calculation (specific gravity).....	81
10-2-3. Principle of optical sensor.....	83
10-2-4. Principle of sonic sensor.....	84
11. Definition of Terms.....	85
11-1. Definition of terms used in operating manual.....	85
11-2. Definition of terms used in "Measuring gas specification sheet".....	86

1

Important Notices on Safety

1-1. Danger cases



DANGER

<About explosion-proof>

- Satisfy the following installation requirements of the calorimeter.
- Do not open the lid during operation.
- Turn off the power of the calorimeter before replacing the fuse.
(Fuse specifications: 250 V, 1 A, $\Phi 5 \times 20$ mm, time lag type)
- Do not disassemble/modify the calorimeter, or change the settings if not necessary.
Contact RIKEN KEIKI for information on readjustment including gas calibration and parts replacement.
- Do not replace parts at your sole discretion but contact RIKEN KEIKI if the transparent window has a crack or the explosion-proof joint surface is abnormal, or the clamping screw or bolt is changed, lost etc.
- Never fail to perform a regular maintenance.
- Use appropriate cables to wire.
- Use ring terminals etc. for electrical connections and ensure safe connection without any slack or tangle.
- Use ring terminals to connect the grounding terminal with the ground and use the grounding wire with cross-sectional area of 4 mm^2 or more for the external grounding terminal.
- The transparent window is made of polycarbonate resin. Be careful that it may be damaged by an atmosphere of toluene, benzene, ammonia, aromatic hydrocarbon etc.
- Do not repair the explosion-proof joint surface.
- Use a control key (magnet) specified by RIKEN KEIKI.
- Gas conditions (Explosion protection conditions)

Maximum flow rate	Measuring gas (GAS IN) 1 L/min
	Reference gas (REF IN) 0.5 L/min
Pressure	80 to 110 kPa for all of GAS IN, REF IN, and OUT
Temperature	-20 to 57°C for all of GAS IN, REF IN, and OUT (Japanese explosion-proof spec.)
	-20 to 60°C for all of GAS IN, REF IN, and OUT (Overseas explosion-proof spec.)

1-2. Warning cases



WARNING

<About explosion-proof>

Do not open the front lid of the OHC-800 if the existence of an explosive atmosphere is suspected.



WARNING

<Power>

Before turning on the calorimeter, always check that the voltage is properly applied. Do not use an unstable power supply because it may cause malfunctions.

The settings in the calorimeter vary depending on the AC and DC power specifications (See the figure below).

The calorimeter is damaged if incorrect power is supplied to incorrect settings.

Check the specifications and supply the correct power.

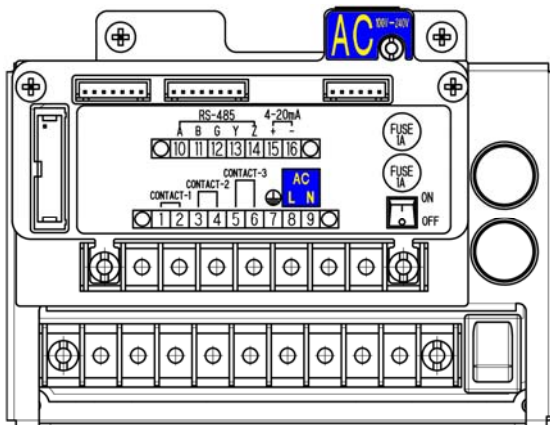

Power terminal unit with
AC specifications

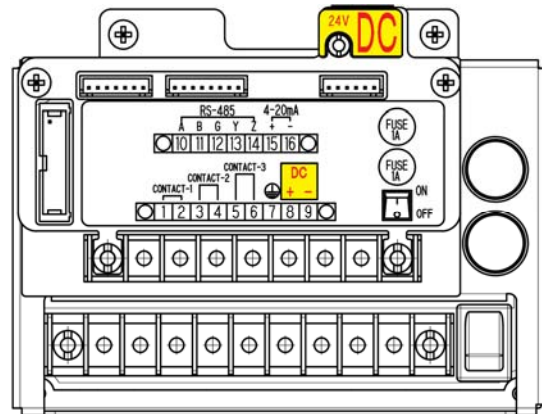

Power terminal unit with
DC specifications

<Need of protective grounding>

Do not cut the grounding wire or disconnect the wire from the grounding terminal.

<Defects in protective functions>

Before starting the calorimeter, check the protective functions for defects. When seeming defects are found in the protective functions, such as protective grounding, do not start the calorimeter.

<External connection>

Before connecting the calorimeter to the external device, securely connect it to the protective

1-3. Precautions



CAUTION

Do not use a transceiver near the calorimeter.

Radio wave from a transceiver near the calorimeter or its cables may disturb indication reading. If a transceiver is used, it must be used in a place where it disturbs nothing.

To restart the calorimeter, wait for five seconds or more before doing it.

Restarting the calorimeter within five seconds may cause errors.

Do not disassemble/modify the calorimeter, or change the settings if not necessary.

Disassembling/modifying the calorimeter will invalidate the warranty of the performance. Changing the settings without understanding the specifications may cause malfunctions. Please use the calorimeter properly in accordance with the operating manual.

Avoid applying organic solvents and others to the window plate for a long time.

The window plate material is a polycarbonate resin. When organic solvents (liquid or highly-concentrated vapor) and others are applied to the plate for a long time, its color and shape may be changed.

1-4. Method of confirmation for Standards and Explosion proof specification

This instrument has some specification depends on standard and explosion proof certificate. Please confirm the detector specification before using. Please refer Declaration of Conformity that is at the end of this manual if you have CE marking type.

You can confirm instrument specification to see name plate as follows.

Ex marking

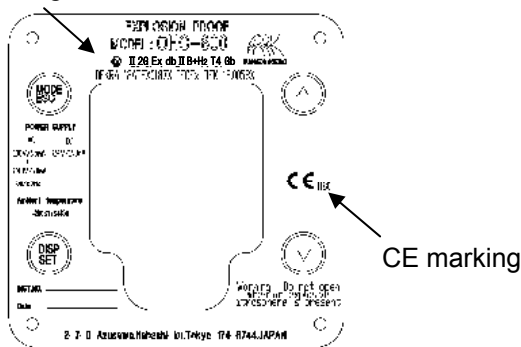

ATEX/IECEx, CE marking type name plate

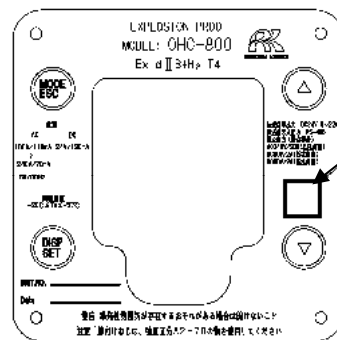

TIIS type name plate

1-5. Information about explosion-proof performance (Japanese explosion-proof spec.)

1-5-1. About OHC-800

The OHC-800 is an explosion-proof calorimeter. According to measured calorific values, 4 - 20 mA signals and digital signals are output.

The calorimeter is used for the purposes of calorific value recording and device control by connecting it to a recorder or a programmable controller.

The calorimeter has three contact outputs and these are activated by malfunction etc. of the device.

1-5-2. Technical data

Explosion-proof structure		Flame-proof enclosures
Certificate number (TIIS)		No. TC20344
Explosion-proof class		Ex d II B+H ₂ T4
Ambient temperature		-20 to 57°C
Rating	Power supply	100 VAC/110 mA - 240 VAC/70 mA, 50/60 Hz, 24 VDC/190 mA
	Analog signal output	24 VDC/0 - 22 mA
	Digital signal input-output	RS-485 (MODBUS)
	Contact output (Contact capacity)	240 VAC/20 W (Load resistance) 30 VDC/2 A (Load resistance) 30 VDC/2 A (Load resistance)
Applied standard		JNIOOSH—TR—NO.43 (2008)

Manufacturer: RIKEN KEIKI CO., LTD.

2-7-6 Azusawa, Itabashi-ku, Tokyo, 174-8744 Japan
Web site: <http://www.rikenkeiki.co.jp/>

1-5-3. System configuration for use in hazardous location

The OHC-800 has a flame-proof enclosure (Explosion-proof class: Ex d II B+H2 T4) and can be used in a Class 1 location. However, if the power source and display instrument etc. connected to it do not have an explosion-proof structure, install it in a non-hazardous area.

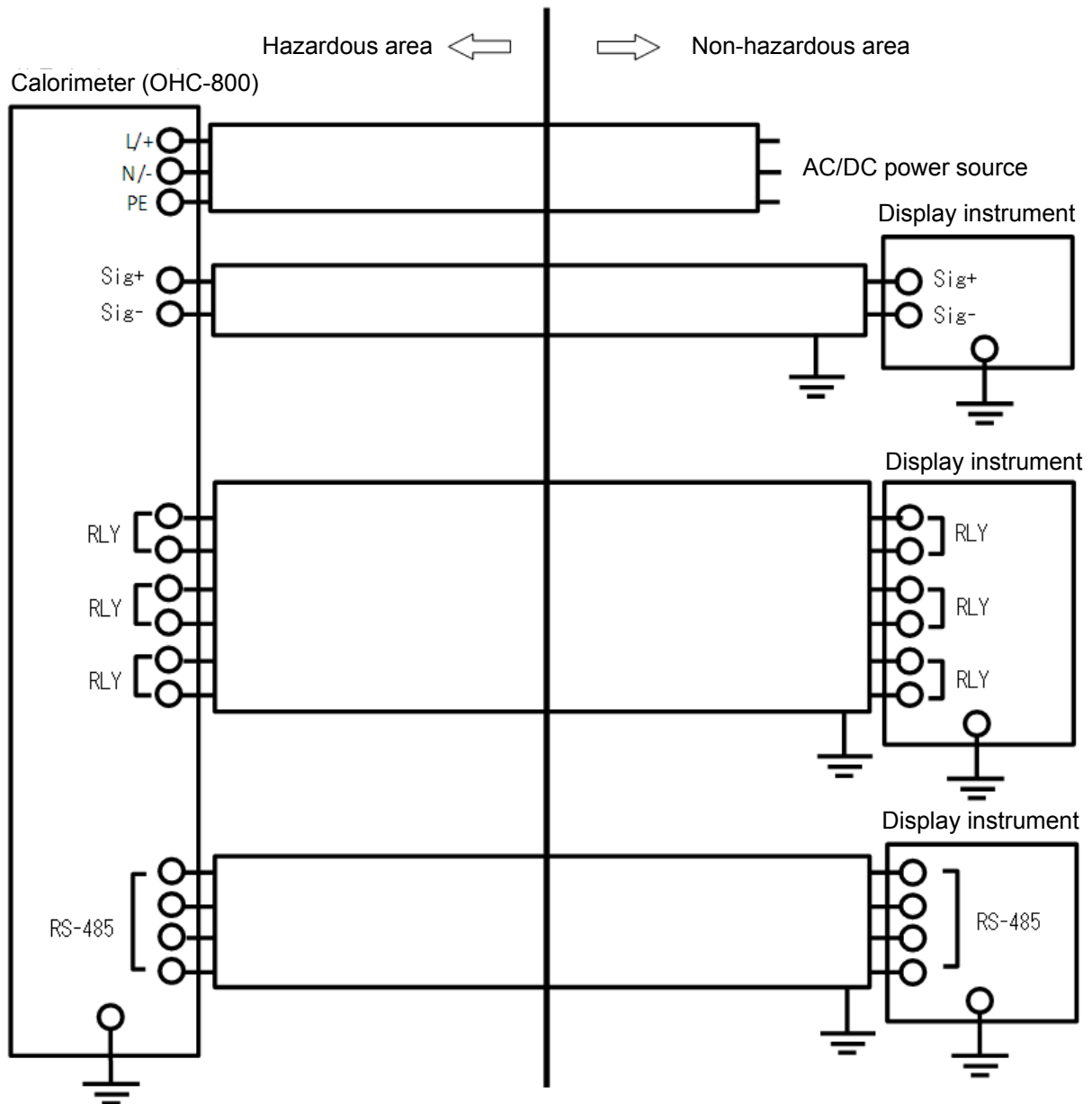

1-6. Information about explosion-proof performance (Overseas explosion-proof spec.)

1-6-1. About OHC-800

This product is a sample draw type fixed Calorimeter.
2 power inputs, AC and DC, are available on the Calorimeter.

1-6-2. Technical data

(Name) :CALORIMETER

(Type) :OHC-800

(Protection Method) : Flameproof enclosure "d"

(Certificate numbers)IECEX DEK 12.0058X
DEKRA 12ATEX0187 X

(Group) : II

(Category) : 2G

(Type of Protection and Marking code) : Ex db IIB+H₂ T4

(Equipment Protection Level) : Gb

(Ambient Temperature) : -20°C ~ 60°C

(Electrical Data):

Supply voltage : 100VAC/95mA~240VAC/70mA 50 /60 Hz
or 24 VDC/190mA

Contact output : 30VDC/2A

Contact output : 240VAC/1A

Output signal : 4-20mA (24 VDC/20mA)

Digital Communication :RS485

(Applicable Standard) EN 60079-0:2012+A11:2013, EN 60079-1:2014
IEC 60079-0:2011, IEC 60079-1:2007

1-6-3. System configuration for use in hazardous location

Installation Diagram

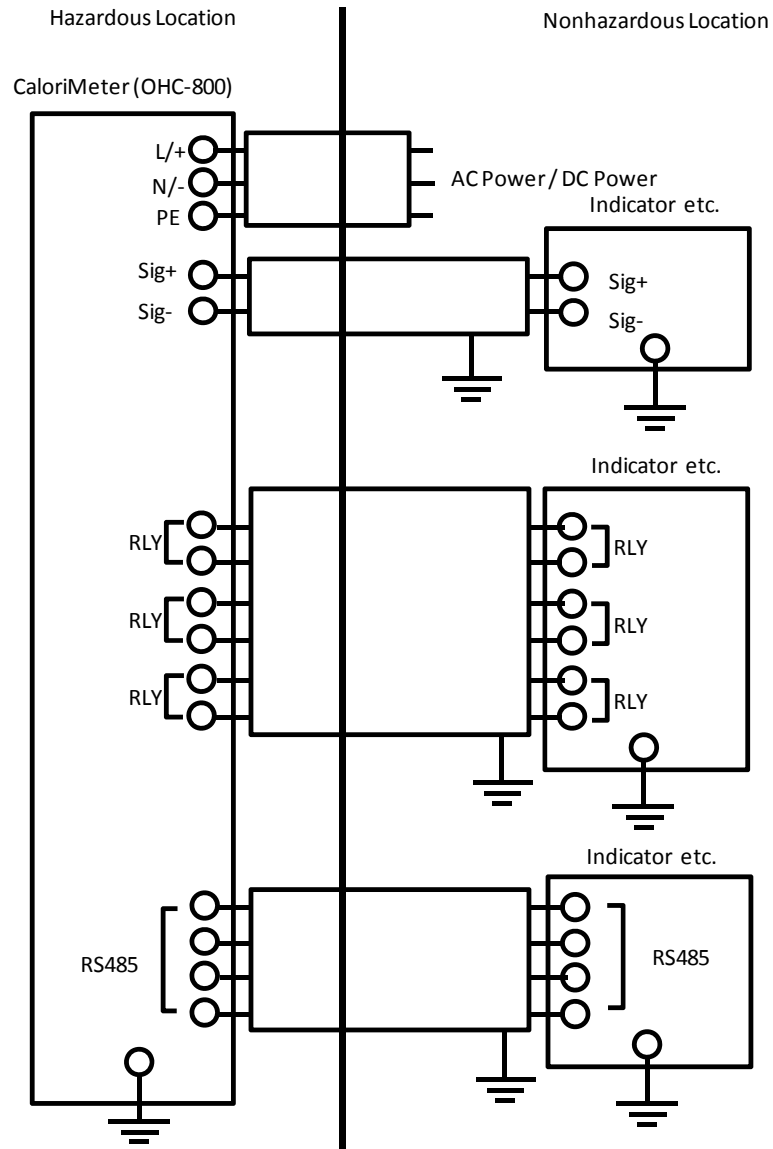

1-6-4. Notice on safety

WARNING

- Do not open when an explosive atmosphere is present.

Caution

- Do not open the cover while in operation.
- Do not take apart, remodel and change the instrument.
- Contact the nearest Riken Keiki's agents or Riken Keiki to perform adjustment, including the gas calibration, and parts replacement etc.
- Contact the nearest Riken Keiki's agents or Riken Keiki if any abnormalities are found.
- Make sure to perform a regular check.
- Make sure to use suitable cables.
- Do not repair the flame-proof composition surface.
- All bolt with the hexagon socket must use the stainless steel material of property class "A2-70".
- The internal and external ground connection shall be made with a cable lug and be secured by additional means to prevent twisting.
- At the internal ground connection the cable lug shall be installed between the washer and the toothed lock washer.

Gas conditions

Composition

IIC gases other than H₂ cannot be used.

Max Flow

Measurement gas:1L/min Reference Gas:0.5L/min

Pressure range

Measurement Gas Reference Gas Out Gas : 80~110kPa

Temperature

Measurement Gas Reference Gas Out Gas :-20~60°C

- In case oxygen presents in the sampling gas which is supplied into OHC-800 and emitted from OHC-800, contents of oxygen should be lower than that normally present in air.
- The sampling gas which is supplied into OHC-800 and emitted from OHC-800 should not be within the explosive limits continuously for long period or frequency.
- Power on the measuring system after pipings in the enclosure are purged with process gas.
Also, power off the measuring system while pipings in the enclosure are purged with process gas.
- Periodic maintenance service shall be performed to check if there is no failure of the gas containment.

Earth terminal

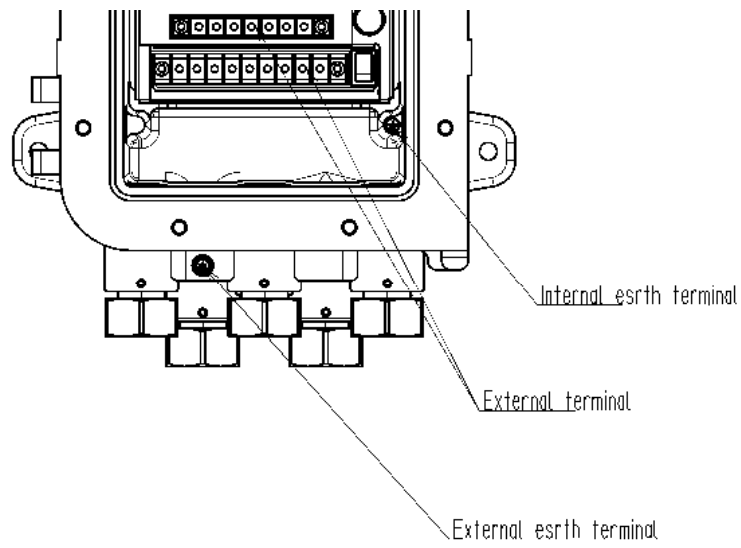

Cable gland

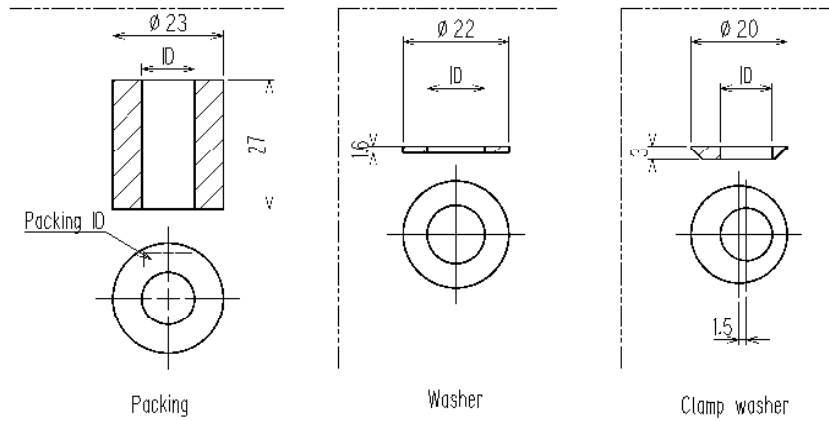
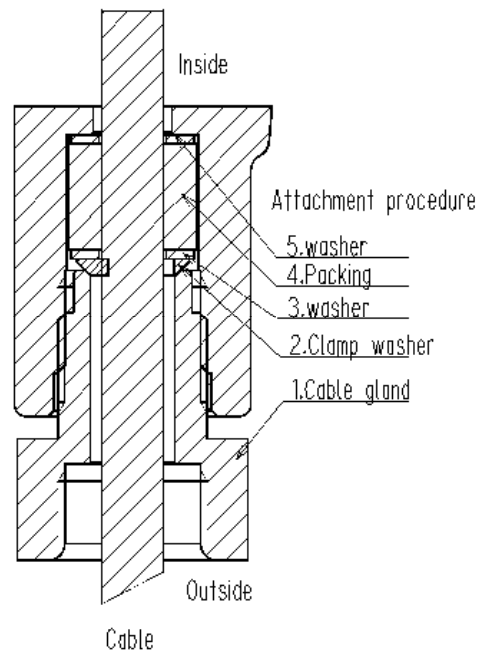

table 1. Parts of Cable entry, size combination table

Cable OD	Packing	Washer	Clamp Washer
	ID	ID	ID
9.6-9.8	10	12	9.8
10.0-10.8	11	12	10.8
11.0-11.8	12	14	11.8
12.0-12.8	13	14	12.8
13.0-13.8	14	14	13.8

Please install a cable gland into OHC-800 according to the following figure.



Please tighten a bolt of a cable gland at $40\text{N}\cdot\text{m}$ or more

Special conditions for safe use

- Repair of the flameproof joints is not allowed.
- Fasteners have property class A2-70.

2

Product Components

2-1. Purpose of use and features of this product

- This calorimeter is an explosion-proof calorimeter in a flame-proof enclosure designed for continuous, fast-response measurement of the "Calorific value," "Density," and "WOBBE index" of various fuel gases such as natural gas, coke oven gas, blast furnace gas, converter gas, biomass gas, and biogas. The types of fuel gases that can be measured depend on the specifications. For information on the types of gases that can be measured by the product, check the "Measuring gas specification sheet" provided with it.
- The calorimeter measures the speeds of "light" and "sound" that travel through the measuring gas by using an "optical sensor" and a "sonic sensor" and applying the Opt-Sonic calculation processing* to the measuring result. This enables the high-accuracy measurement of "Calorific value" and "Density" of fuel gases containing interference gases such as nitrogen and carbon dioxide.

NOTE

For information on Opt-Sonic calculation, see Section 10.2, "Principle of this product."
Opt-Sonic calculation is a coined word by RIKEN KEIKI.

- The calorimeter can be used with minimum equipment even under constraint conditions with its high environmental resistance.
- The calorimeter, having an advanced self-monitoring/diagnostic function compliant with NAMUR NE107 (self-monitoring/diagnostic of field devices), offers functions for performing real-time status monitoring for devices and informing abnormal statuses and maintenance requests with LCD display and contact output.
- The calorimeter has a log data auto-save function that records the history of "operation statuses" and "self-diagnostic results" for a year or longer. Furthermore, another function provides outputting the log data via IrDA communication, which can be used for high-quality maintenance/follow-up services. (Optional services)
- The calorimeter forms a "complete stand-alone unit structure" that consists of standardized units. Even if any malfunction occurs, quick repair and recovery can be achieved just by replacing a faulty unit on site.

2-2. Main unit and standard accessories

<Main unit> (including cable glands)

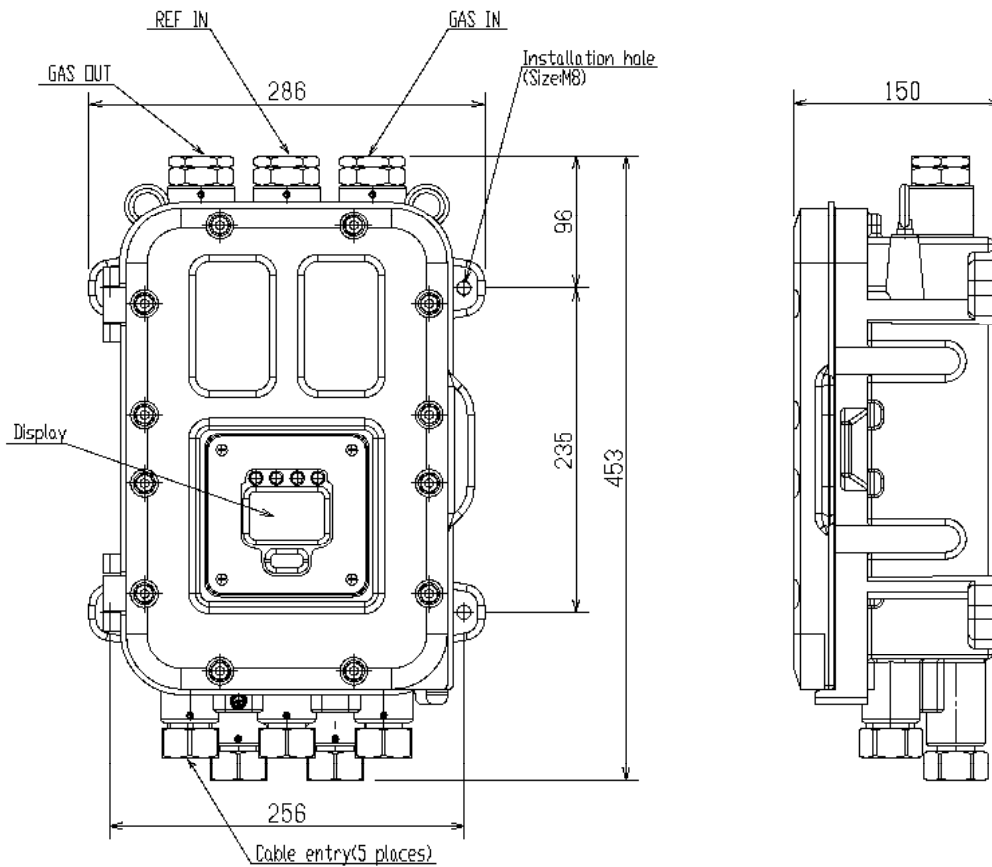

<Standard accessories>

- Operating manual
- Measuring gas specification sheet
- Dedicated control key (magnet)
- Hex key wrench (2 mm and 6 mm, one each)
- Fuse (250V 1A Φ 5 x 20 mm, two)



CAUTION

- Use the supplied dedicated magnet control key to operate the calorimeter. If products other than these accessories are used, key operations cannot be accepted properly.
- The magnet control key is made of an extremely strong magnet. Keep it away from a credit card, ID card, or other magnetic product because stored data may be destroyed.

2-3. Names of internal product components

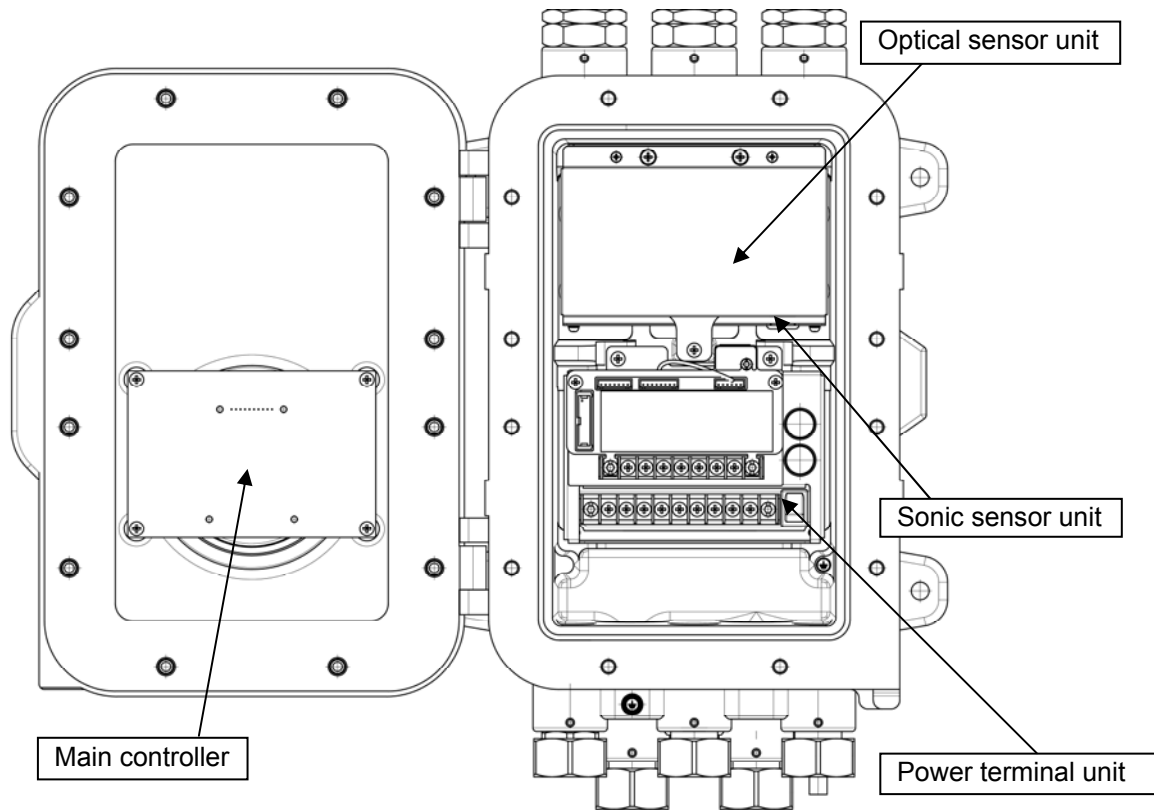

Name	Functions
Optical sensor unit	Measures the speed of light that travels through the measuring gas by capturing the refractive index. In addition, this unit monitors the flow rates of the measuring gas and REF gas.
Sonic sensor unit	Measures the speed of sound that travels through the measuring gas.
Power terminal unit	Supplies power to other units. This unit relays signals between units, performs contact output, and outputs 4 - 20 mA analog signals and RS-485 (MODBUS) communication signals.
Main controller	Calculates and displays the "Calorific value," "Density," and "WOBBE index" based on data received from the optical sensor unit and the sonic sensor unit. Also converts the units of "Calorific value" and "Density." Checks the operation statuses of other units to ensure normal measurement and output.

2-4. Names and functions of display

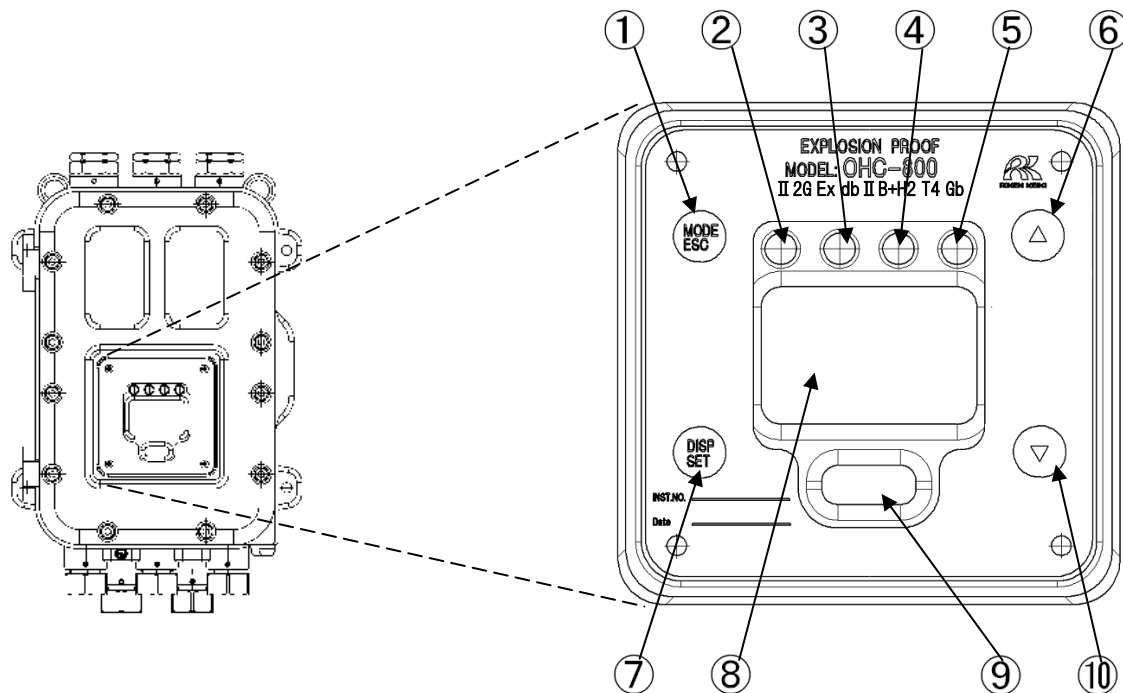

① MODE/ESC key	Switches MEASURING MODE to other mode. ----- Used to stop processing.
② POWER lamp (green)	Lights up at power-on.
③ EV1 lamp (orange)	Lights up in conjunction with Contact Output 1.
④ EV2 lamp (red)	Lights up in conjunction with Contact Output 2.
⑤ EV3 lamp (green)	Lights up in conjunction with Contact Output 3.
⑥ ▲ key	Moves the cursor or increases the setting value.
⑦ DISP/SET key	Switches the display content in MEASURING MODE. ----- Confirms processing etc.
⑧ LCD display	Displays measurement values, operation statuses, or other information.
⑨ IrDA communication port	The IrDA communication port for maintenance. Reads event log or daily log information recorded on the product.
⑩ ▼ key	Moves the cursor or decreases the setting value.

Use the attached magnet control key to operate all the switches described in the above table. Holding the magnet control key over the switch marks for a few seconds will start the switches. The description of "press the XXX switch" in this operating manual means holding the magnet control key over the marks ● and ▼▲.

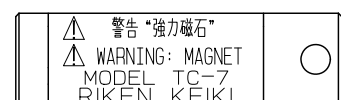

Control key (magnet)

3

How to Install Calorimeter

3-1. Precautions on installation site

Use the calorimeter in combination with a sampling device specified by RIKEN KEIKI (or an equivalent cubicle). Do not install this product in any of the following locations.

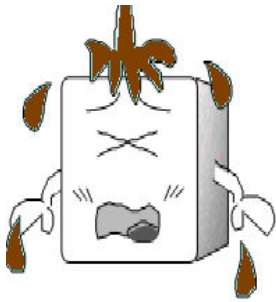

(1) Place where the calorimeter is exposed to oil, chemicals etc.

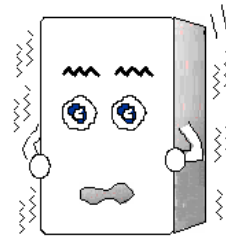

(2) Place with vibrations

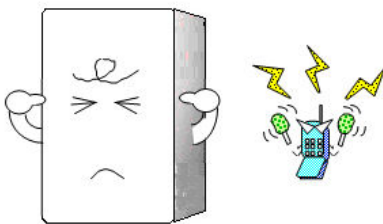

(3) Place where radio wave or noise is generated

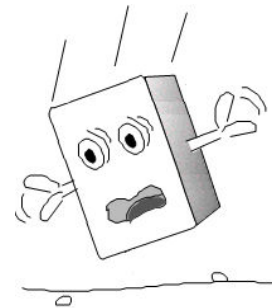

(4) Place where the calorimeter may drop or receive strong shock

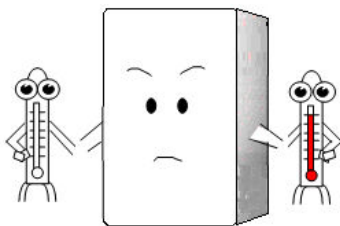

(5) Place exceeding the operating temperature range

Place where the calorimeter is exposed to direct sunlight or radiant heat

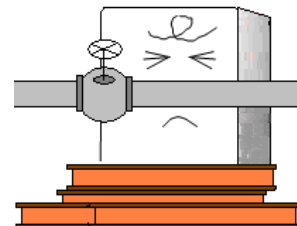

(6) Place where maintenance of the calorimeter cannot be performed
Place where handling of the calorimeter involves dangers

3-2. Installation procedure and required maintenance space

Install the OHC-800 and the sampling device on the surface of a robust wall or a freestanding rack etc. using bolts.

Before installation, a maintenance space shown in the figure on the right must be secured. Be sure to secure this space during construction planning or installation.

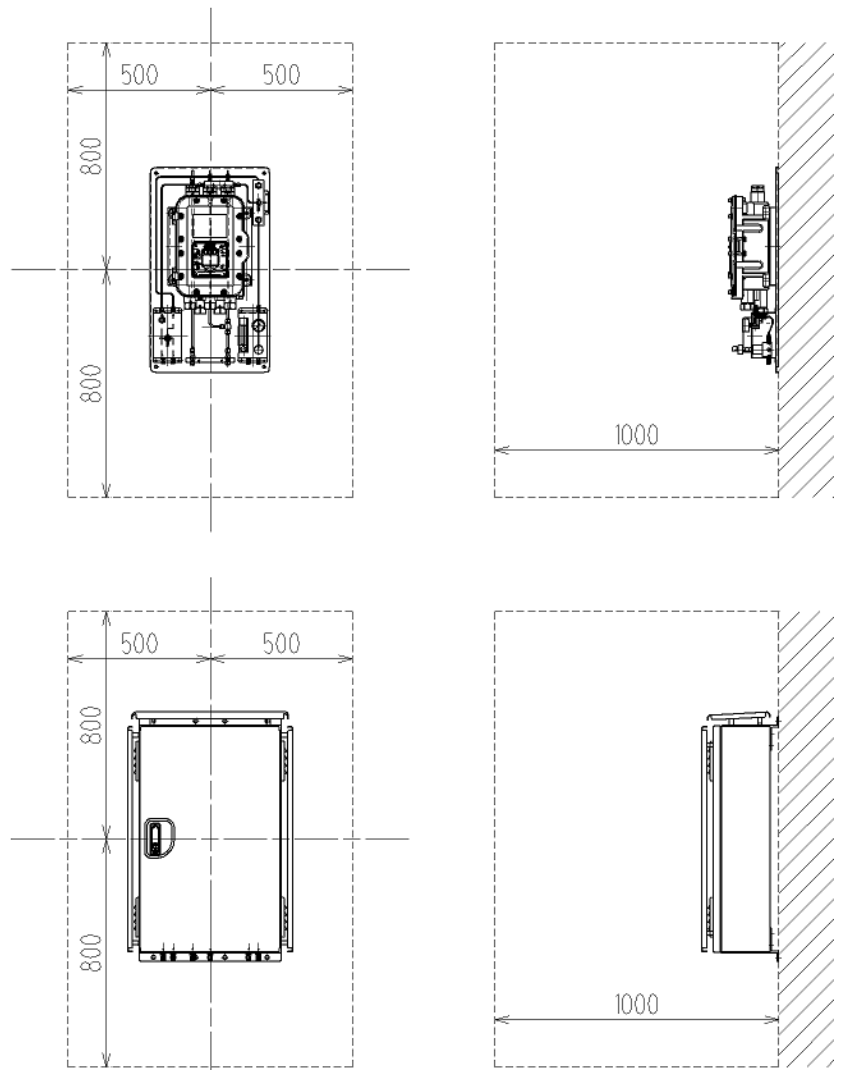

Maintenance space (Unit: mm)



CAUTION

- Do not drop or give strong shock to the calorimeter during transportation or installation. Otherwise, the calorimeter may be damaged, or the explosion-proof performance may be lost.
- When installing the calorimeter on a freestanding rack (fixed type), fix the freestanding rack with anchor bolts.
- If the calorimeter is to be fixed on the wall, install it properly where it can hold its weight.
- When performing construction work, prevent dust from entering the inside of the calorimeter.

3-3. How to connect wire

3-3-1. Description of terminal block

Open the front lid of the OHC-800 to find the terminal block shown in the figure below. The terminal block has the layout shown in the table below.

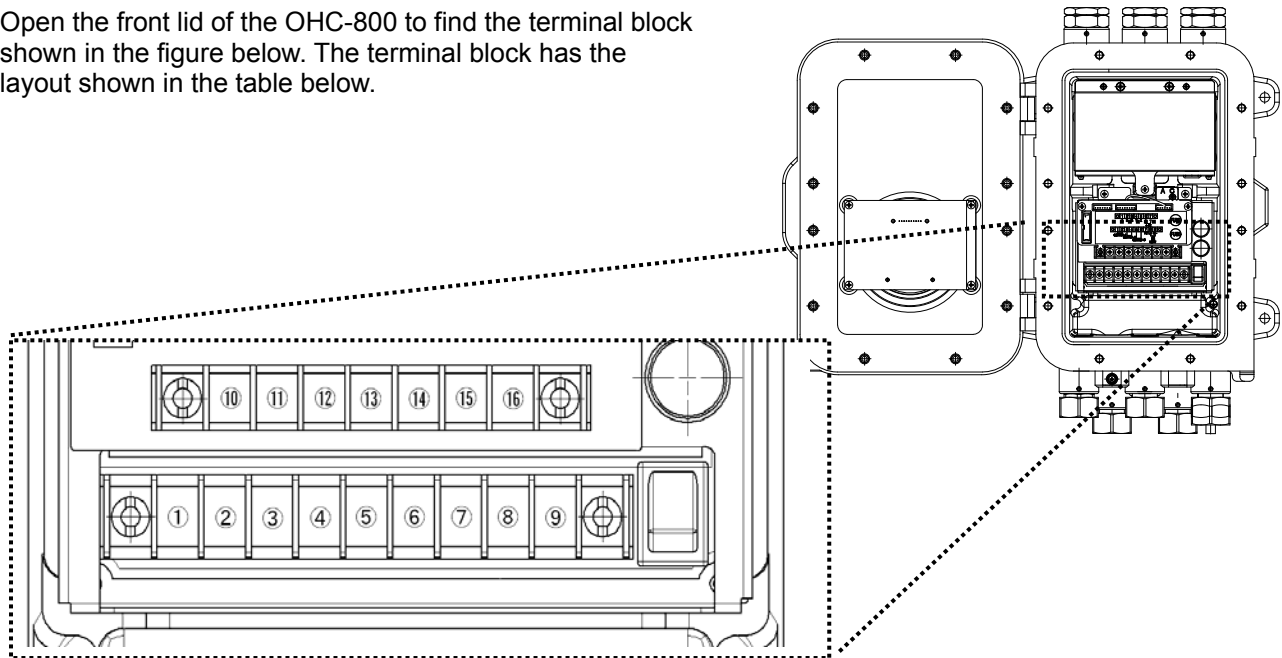

(1)	Contact output 1	CONTACT 1	Activates if the FUNCTION CHECK condition is met or the OUT OF SPECIFICATION condition is met. [No-voltage contact, contact capacity of 2 A, 30 VDC (resistance load)]
(2)			
(3)	Contact output 2	CONTACT 2	Activates if the FAILURE condition is met. [No-voltage contact, contact capacity of 2 A, 30 VDC (resistance load)]
(4)			
(5)	Contact output 3	CONTACT 3	Activates if the MAINTENANCE REQUIRED condition is met. [SSR contact, contact capacity of 20 W, 240 VAC (resistance load)]
(6)			
(7)	Power	FG	Protective grounding (EARTH) less than 100 Ω of the grounding resistance
(8)		L / +	100 - 240 VAC ±10%, 50/60 Hz, max. 18 VA
(9)		N / -	or 24 VDC ± 10%, max. 5 W

(10)	RS-485 communication	A	Input-output terminals for communication via RS-485 (MODBUS)
(11)		B	
(12)		G	
(13)		Y	
(14)		Z	
(15)	4 - 20 mA external output	(+)	4 - 20 mA DC (isolated, source current type) maximum load resistance of 300 Ω Minimum resolution of 0.01 mA or less
(16)		(-)	

M4 is used as the terminal screws for the terminal block. Attach an insulated ring terminal for M4 to the tip of a cable for wiring.

NOTE

If you are considering the use of the RS-485 (MODBUS) communication function, contact RIKEN KEIKI.



CAUTION

Contact output 3 (SSR)

- Contact output 3 is SSR output.
- AC power is required to activate Contact output 3

Method of changing the output from SSR to contact

- Add an external relay outside of OHC-800.

Contact output 3 is SSR output. (Load specification: 75 VAC - 264 VAC, Electronic current 20mA - 1A)
For this reason, the power terminal unit with DC specifications can not be used as it is when SSR output is taken into.

In this case, add an external AC relay outside of OHC-800 and change the output from SSR to dry contact.

< Wiring diagram >

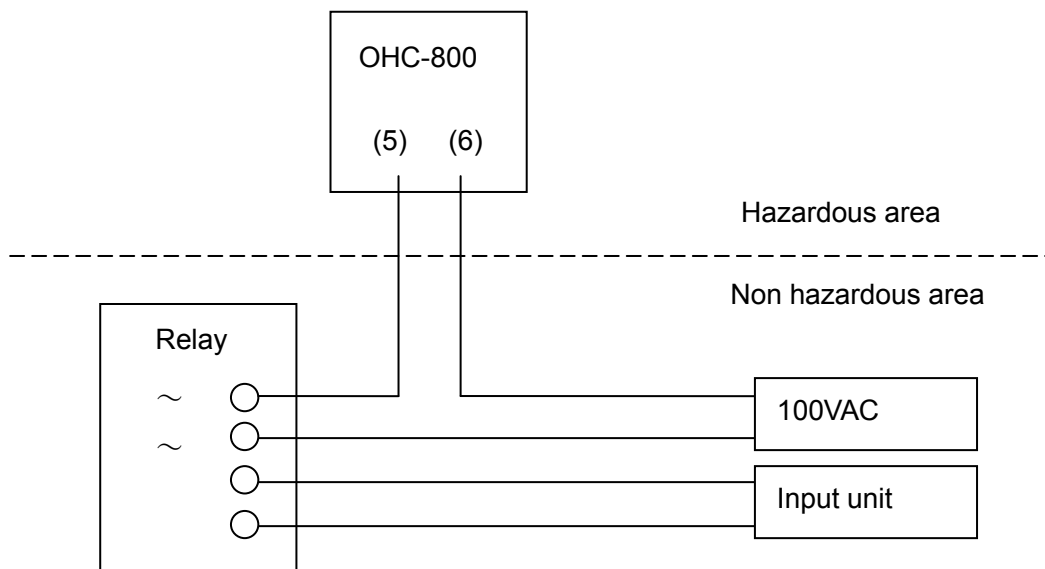

- Install the AC relay into non hazardous area
- Use a relay that coil specification is voltage 75 VAC - 264 VAC, electronic current 20mA - 1A.
Example) MK3ZP (OMRON): Rating current 23.1mA (100VAC, 60Hz)

3-3-2. Recommended cables

Connected to	Recommended cable	Cable overall outer diameter
Power (AC) line	CVV 1.25 sq/3-core	Φ10.0
	CVV 2 sq/3-core	Φ11.0
Power (DC) line	CVVS 1.25 sq/2-core	Φ10.0
	CVVS 2 sq/2-core	Φ11.0
4 - 20 mA line	CVVS 1.25 sq/2-core	Φ10.0
	CVVS 2 sq/2-core	Φ11.0
Contact x 1 line	CVVS 1.25 sq/2-core	Φ10.0
	CVVS 2 sq/2-core	Φ11.0
Contact x 2 lines	CVVS 1.25 sq/4-core	Φ11.0
	CVVS 2 sq/4-core	Φ12.0
Contact x 3 lines	CVVS 1.25 sq/6-core	Φ13.0
	CVVS 2 sq/6-core	Φ14.0
RS-485 line	CVVS 1.25 sq/5-core	Φ12.0
	CVVS 2 sq/5-core	Φ13.0

CVV = Control -use Vinyl insulated Vinyl sheathed cable

CVVS = Control -use Vinyl insulated Vinyl sheathed cable with shield

NOTE

The overall outer diameters must be checked because they may somewhat vary between manufacturers.

3-3-3. How to lead in and connect cables

As shown on the right side of the figure below, attach the parts in the following order: (1) cable gland, (2) clamp washer, (3) washer, (4) rubber seal, and (5) washer to the cable, then connect the cable into lead-in port through the enclosure by attaching an insulated ring terminal to the tip in order to complete the connection to the terminal block.

An unused cable lead-in port must be closed with a rubber seal and a seal plug as shown on the left of the figure below.

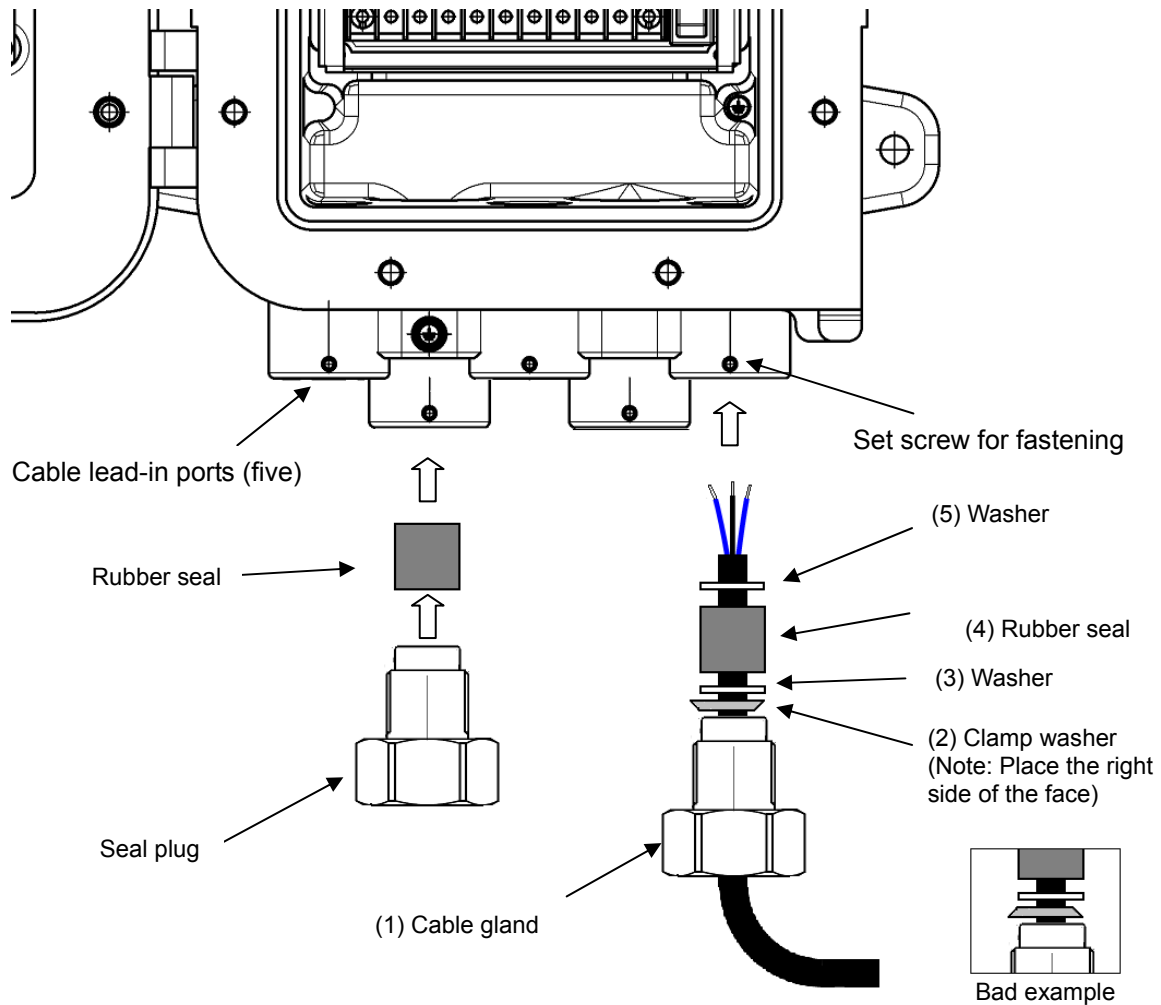

CAUTION

- Ensure the tightening torque for the cable gland and seal plug to be 40 N·m or larger.
- If it is difficult to tighten the cable gland and seal plug, grease its screw part and then tighten them with the tool.
- After completing tightening of the cable gland and seal plug, use a set screw for fastening to prevent it from loosening.
- To improve noise immunity, connect the shield of the CVVS cable inside the enclosure.

The rubber seals, washers, and clamp washers needed for cable connection vary depending on the overall outer diameter of a cable to be used. The table below shows the relationships between the overall outer diameters of cables and inner diameters of parts. Please specify parts needed for cables to be used.

Cable overall outer diameter (mm)	Rubber seal inner diameter (mm)	Washer inner diameter (mm)	Clamp washer inner diameter (mm)
Φ10, Φ10.5	Φ11	Φ12	Φ10.8
Φ11, Φ11.5	Φ12	Φ14	Φ11.8
Φ12, Φ12.5	Φ13	Φ14	Φ12.8
Φ13, Φ13.5	Φ14	Φ14	Φ13.8

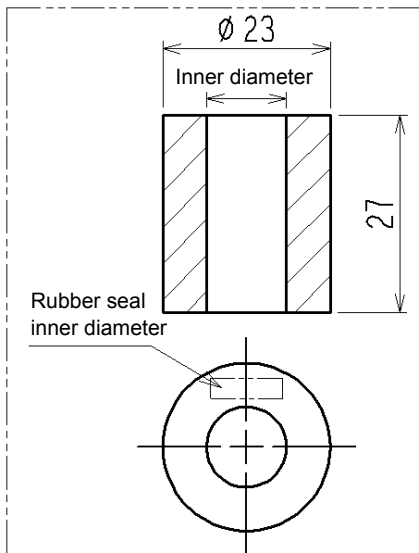

Rubber seal

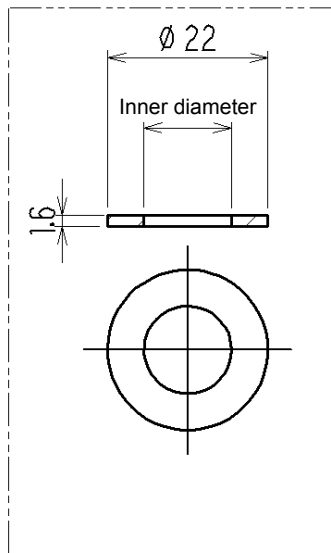

Washer

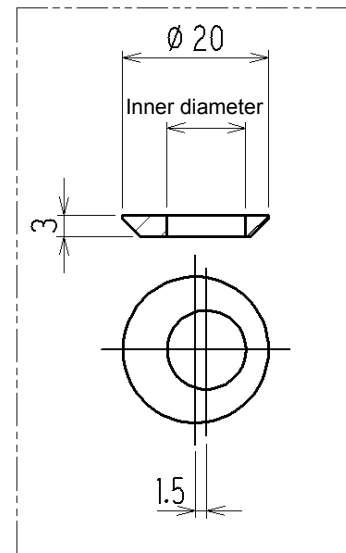

Clamp washer

(Unit: mm)

3-3-4. Protective grounding

Connect the calorimeter to the ground using the "external grounding terminal" or "No.(7) of the terminal block" shown in the figure below.

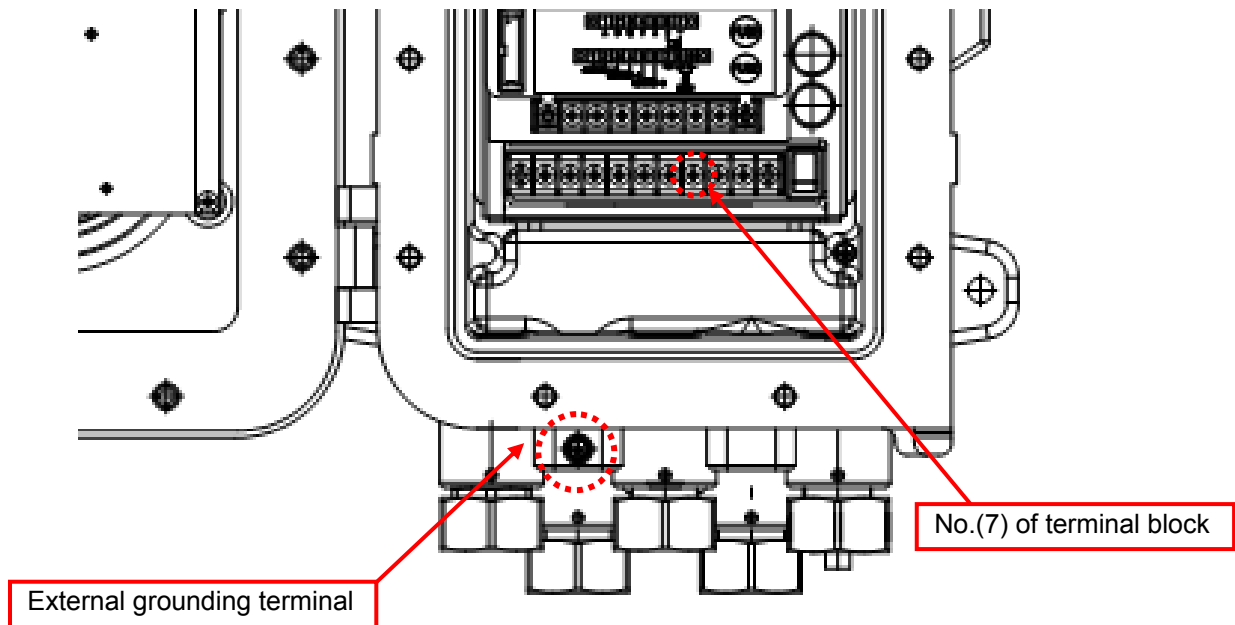

WARNING

- Before turning on the calorimeter, never fail to connect it to the ground.
- Ensure to connect the calorimeter to the ground for stable operation and safety. Do not connect the grounding wire to a gas pipe.
- Ensure the grounding to be D type grounding or equivalent (less than 100 Ω of the grounding resistance).
- Use cable lugs for the grounding wire without any slack or tangle for safe connection.

3-3-5. Precautions on electrical work



CAUTION

- Be careful not to damage the internal electronic circuit when wiring. In addition, be careful not to apply stresses on the calorimeter due to load or installation of cables.
- Do not install the power cables and signal cables in parallel with motor power cables etc. When these cables must be installed in parallel for unavoidable reasons, put the power cables and signal cables in a metal conduit and connect the conduit to the ground.
- Use ring terminals.
- Use appropriate cables to wire.

Using a stable power supply

Not only when the power is turned on but also when the calorimeter is restarted due to momentary blackout, note that OHC-800 is switched to a warm-up status for 15 minutes and stops measurement for function check status (See Sections 4.1, "From display just after power-on to measurement start" and 4.4, "Self-diagnostic function").

To reduce risk of momentary blackout, use a UPS (uninterrupted power supply) or take other appropriate action.

The calorimeter must be provided with the following power supply.

Power supply voltage (Terminal voltage of the calorimeter)	100 VAC ± 10% - 240 VAC ± 10% [AC specification] 24 VDC ± 10% [DC specification]	
Allowed time of momentary blackout	Up to 40 milliseconds (The calorimeter recovers from momentary blackouts that last 40 milliseconds or longer by restarting itself.)	<u>Example of actions</u> To ensure continuous operation and activation, install a UPS etc. outside the calorimeter.
Others	Do not use it with a power supply of large power load or high-frequency noise.	<u>Example of actions</u> Use a line filter etc. to avoid the noise source if necessary.

Introducing protective measures against lightning

If cables are installed outside the factory/plant, or if internal cables are installed in the same duct as the cables coming from outside the factory/plant, "inductive lightning surge" may be caused by lightning. Because lightning acts as a large emission source while cables act as a receiving antenna, devices connected to the cables may be damaged..

The occurrence of lightning cannot be prevented, and even cables installed in a metal conduit or under the ground cannot be completely protected from inductive lightning surge caused by lightning.

Although complete elimination of damages caused by lightning is impossible, the following protective measures can be taken.

Protection against lightning	<p><u>Take appropriate measures in accordance with the importance of the facilities and the environment.</u></p> <p>Provide protection by a surge protective device (cable arrester). Install a lightning arrester before the field devices and central processing equipment to mitigate any risk due to inductive lightning surge transmitted through the cable. For information on how to use a lightning arrester, please contact the manufacturer.</p>
Grounding	<p>In addition to lightning, there are more sources of surge noise. To protect devices from these noise sources, the devices must be grounded.</p>

* The surge protective device has a circuit to remove a surge voltage which damages field devices. Therefore, signals may be attenuated by installing the arrester. Before installing a lightning arrester, verify that it works properly.

Proper use of contact

If the contact output of this product is used on a line where large inductive load occurs, the following errors may occur due to counter electromotive force generated at the contact.

- Deposition, defective insulation or defective contact at the relay contact
- Damage of any electric parts due to high-voltage generation
- Abnormal operations by an out-of-control CPU

**CAUTION**

- Do not use the contacts of the calorimeter directly for drive control over external devices that generate large inductive load, such as a fluorescent lamp or large-scale motor.
- To control a line where large inductive load occurs, provide an external relay for contact amplification. However, because the coil of an external relay also involves inductive load, select a relay at a lower voltage, and then protect the contact of the calorimeter with an appropriate surge absorbing part, such as a CR circuit.

To control a line where large inductive load occurs, protect the contacts of this product as shown in the figure below.

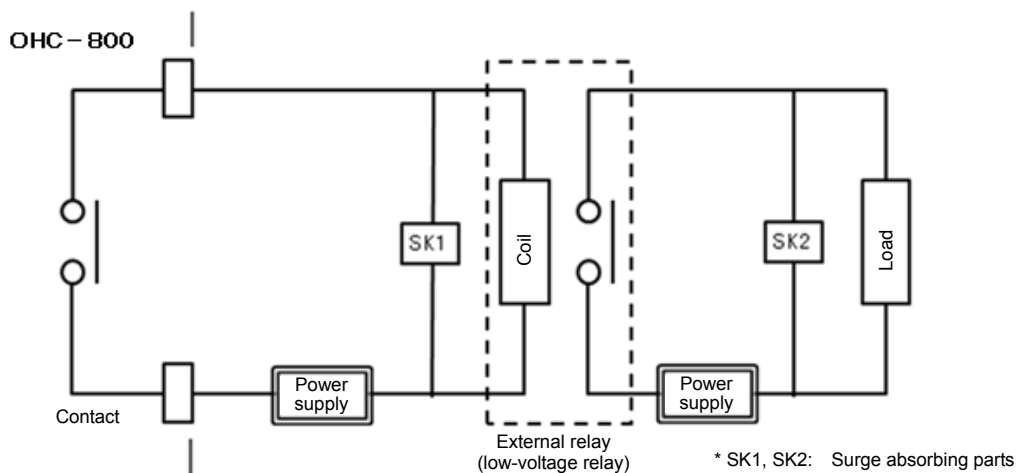

- Relay it with an external relay (contact amplification). At the same time, the surge absorbing part SK1 suitable for the specifications must be attached to the external relay.
- In addition, the surge absorbing part SK2 must be attached to the loaded side of the external relay if necessary.
- It may be recommended that the surge absorbing part should be attached to the contact for certain load conditions. It must be attached to an appropriate position by checking how the load is activated.

3-4. How to tube

3-4-1. Sampling device

Use the OHC-800 in combination with a sampling device RS-400 series specified by RIKEN KEIKI (or an equivalent cubicle etc.).

The figure on the right shows a typical internal tubing system of the sampling device RS-400 series.

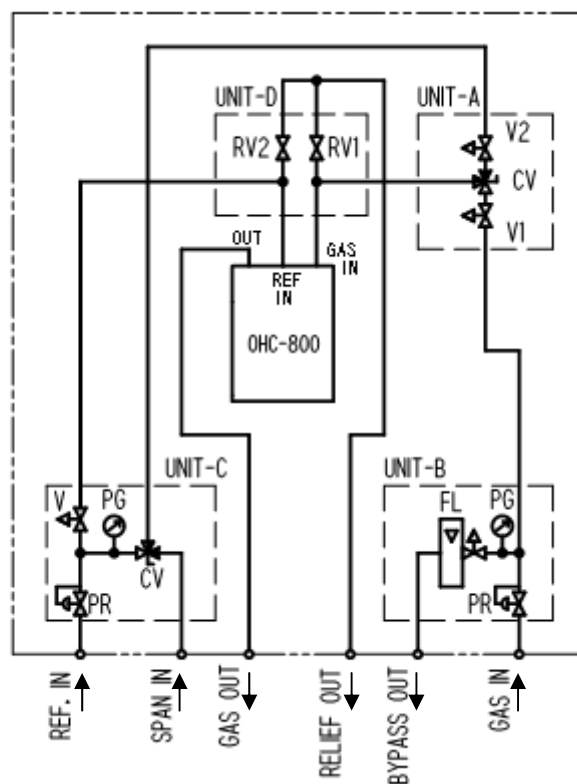

Unit	Symbol	Item	Function / Description
UNIT-A	V1	Needle valve	Adjusts the flow rate of the measuring gas supplied from UNIT-B.
	V2	Needle valve	Adjusts the flow rate of the reference gas or span gas supplied from UNIT-C.
	CV	Switching valve	Selects a gas to be supplied to the OHC-800.
UNIT-B	PR	Pressure regulator	Adjusts the measurement gas supplied from GAS IN to a constant pressure.
	PG	Pressure gauge	Indicates the pressure of the measuring gas after pressure adjustment.
	FL	Flow meter with needle valve	Adjusts and indicates the bypass flow rate of the gas discharged from BYPASS OUT.
UNIT-C	PR	Pressure regulator	Adjusts the reference gas supplied from REF IN to a constant pressure.
	PG	Pressure gauge	Indicates the pressure of the reference gas after pressure adjustment.
	V	Needle valve	Adjusts the flow rate of the reference gas to be supplied to the OHC-800.
	CV	Switching valve	Switches the gas to be supplied to UNIT-A between the reference gas and span gas.
UNIT-D	RV1	Relief valve	When the sampling system malfunctions, relieves the excessive pressure from RELIEF OUT to prevent breakage of the OHC-800.
	RV2	Relief valve	

*) Type without a bypass line is available for UNIT-B.

3-4-2. Recommended external tubing system

If the sampling point is on a high-pressure line over 0.9 MPa, decompression must be performed outside the sampling device. Decompression must be performed as close to the sampling point as possible to ensure the quickest possible arrival of the measuring gas at the OHC-800. (Use the direct-insertion type of pressure regulator if possible.)

Since the OHC-800 consumes approximately 300 mL/min of measuring gas, which is small, the bypass flow rate must be increased to ensure quicker arrival of the gas.

If there is a low-pressure line of about 20 kPa, BYPASS OUT can be connected. If there is no low-pressure line, release the gas from BYPASS OUT into the atmosphere.

Since there is no limit on the arrival time of the reference gas, there is no problem unless the pressure exceeds 0.9 MPa.

The gas from GAS OUT should be released into the atmosphere in principle, but it can be exhaust into an exhaust duct equivalent to the atmospheric pressure (atmospheric pressure ± 3 kPa) if any.

If RELIEF OUT converges on GAS OUT, use tubing with inner diameter of $\Phi 10$ mm or more ($3/8$ " or more) if the length of the tube is 20 m or shorter in order to decrease the load from the converging point to downstream.

The end point of a vent for atmosphere release should form an inverted "T" shape to prevent inflow of rainwater or variations of exhaust pressure due to wind inflow.

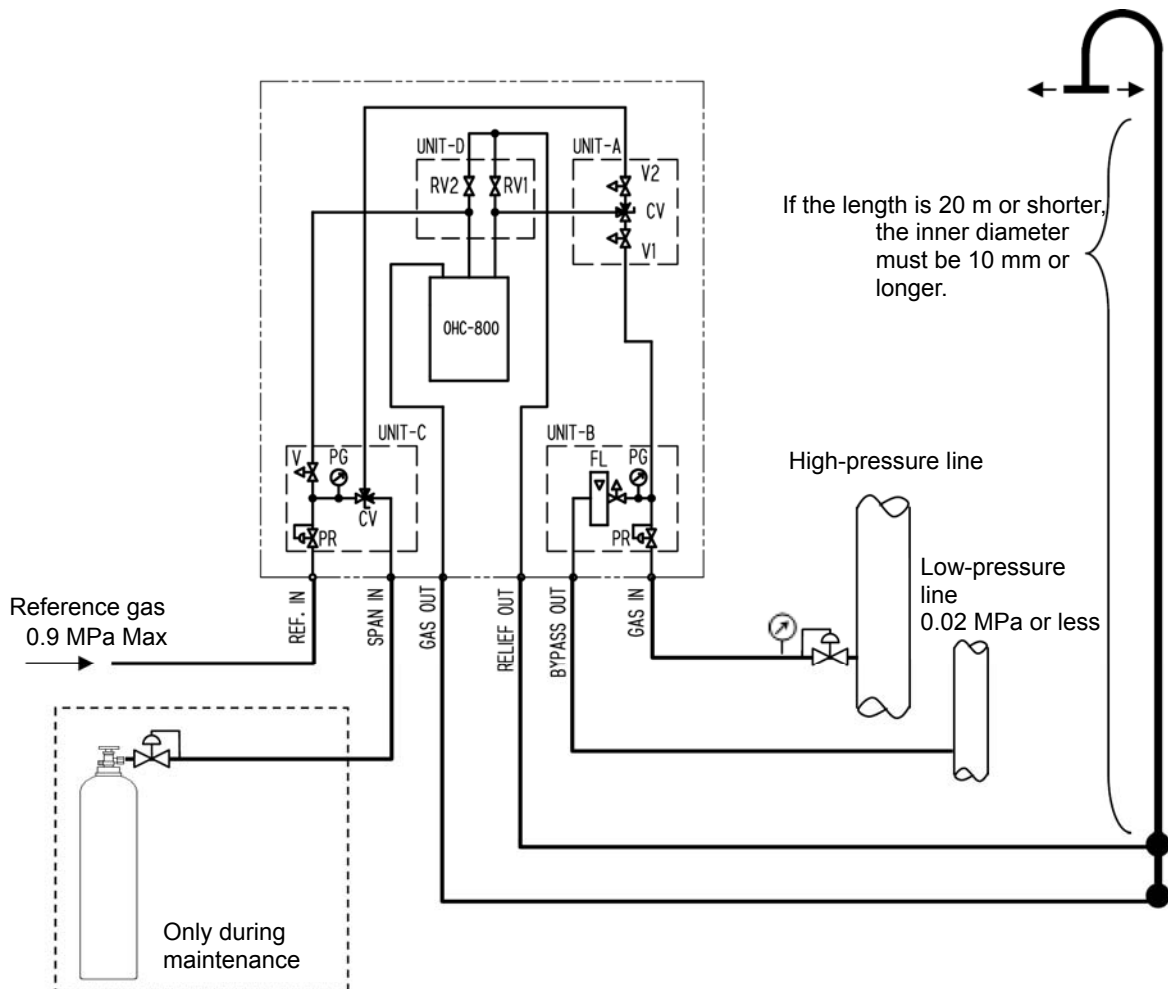

If there is any potential risk of drain or dust inflow, install a trap or filter to prevent inflow of those foreign substances.

The table below shows the guideline values for the "setting pressures of external pressure regulator" and "bypass flow rates" corresponding to the "tubing diameters" and "tubing lengths" from the external pressure regulator to GAS IN of the sampling device in the tubing system shown on the previous page.

Use this table only for your reference because it shows estimated values for assumed arrival time of six seconds or shorter, without any view for upstream tubing structure from external pressure regulator or filters installed at any point of the tubing.

Tubing length Tubing diameter	10 m	20 m
Φ3, 1/8"	Setting pressure: 0.04 MPa Bypass: Not required	Setting pressure: 0.2 - 3 MPa Bypass flow rate: 2 - 5 L/min
Φ6, 1/4"	Setting pressure: 0.1 MPa Bypass flow rate: 2.5 - 5 L/min	Setting pressure: 0.1 MPa Bypass flow rate: 5 L/min
Φ8, 5/16"	Setting pressure: 0.1 MPa Bypass flow rate: 5 - 10 L/min	Setting pressure: 0.1 MPa Bypass flow rate: 10 L/min
Φ10, 3/8"	Setting pressure: 0.1 MPa Bypass flow rate: 10 - 20 L/min	Setting pressure: 0.1 MPa Bypass flow rate: 20 L/min

Use tubing with a large inner diameter for GAS OUT and RELIEF OUT.

	Φ6-4	Φ8-6	Φ10-8
GAS OUT	5 m or shorter	25 m or shorter	-----
RELIEF OUT	0.5 m or shorter	4 m or shorter	10 m or shorter

3-4-3. Precautions on tubing work

- Use stainless tubing.
- After the tube is cut, its cut point may have a smaller inner diameter. Use a file etc. to expand the inner diameter of the cut point.
- Cut-dust of tubing may cause failures of the needle valve, flow rate detection mechanism, three-way switching valve etc. To remove cut-dust remaining inside of the tube, blow compressed air etc., into the tube before connecting it to the calorimeter.
- Determine a sampling point inlet for the measuring gas, considering the airflow of the measuring gas line, unevenness in the manufacturing process of the fuel gas.
- Adjust the measuring gas equivalent to the ambient temperature before supplying it to the sampling device.

4

How to Operate in MEASURING MODE

4-1. From display just after power-on to measurement start

At power-on, the self-diagnostic function starts, and after the initial screen is displayed for about five seconds, the WARM UP screen appears.

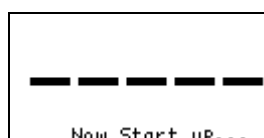

Initial screen



About 5 seconds



WARM UP screen

For 15 minutes after power-on, the OHC-800 remains in the "warm-up state." The warm-up state is classified into the "check of functions (FUNCTION CHECK)" category. In the standard setting, the OHC-800 does not perform measurement, and 4 - 20 mA signals are output according to the setting value specified by the user.

Related sections	4.4, "Self-diagnostic function" 5.2.6, "Check of 4 - 20 mA settings" 6.2.3, "4 - 20 mA condition settings"
------------------	--

When warm-up is completed, measurement is started. At the start of measurement, the screen shown below is displayed.

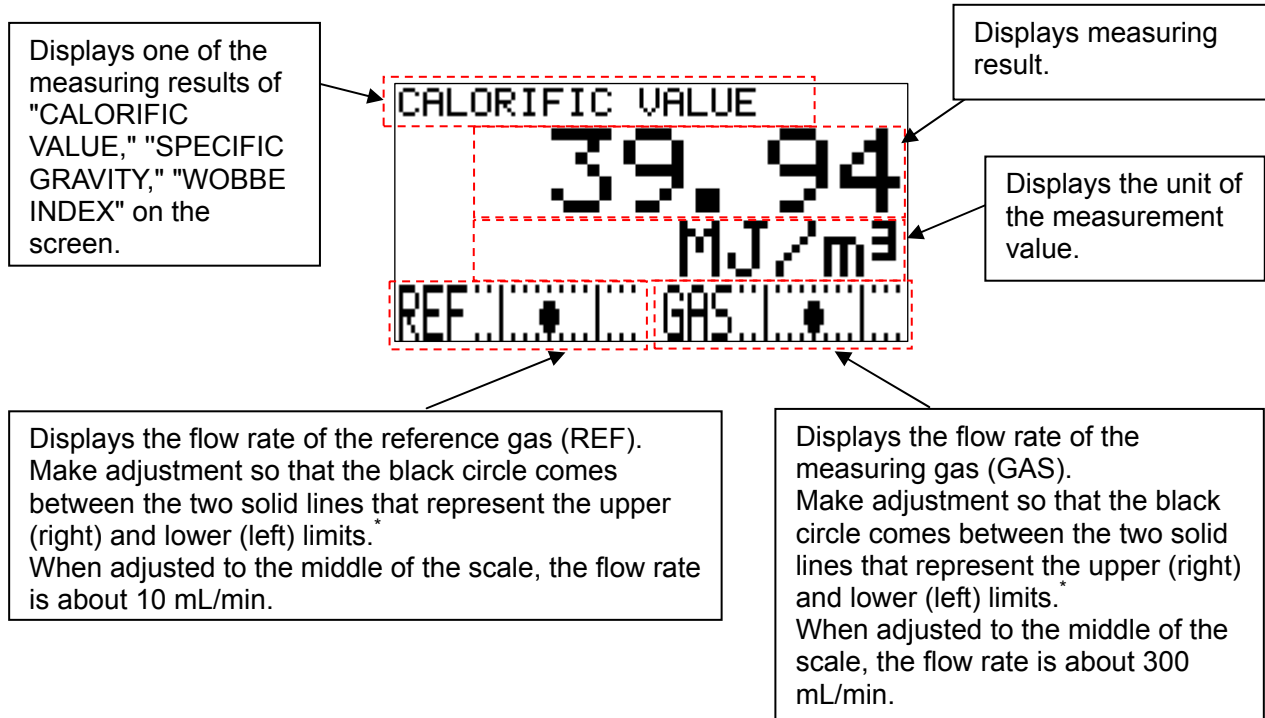

* To perform measurement with a higher accuracy, adjust the black circle to the middle of the scale.

4-2. How to switch display screens

Press the DISP key during measurement to switch the display among "Calorific value," "Density," "WOBBE index," and "Cyclic display."

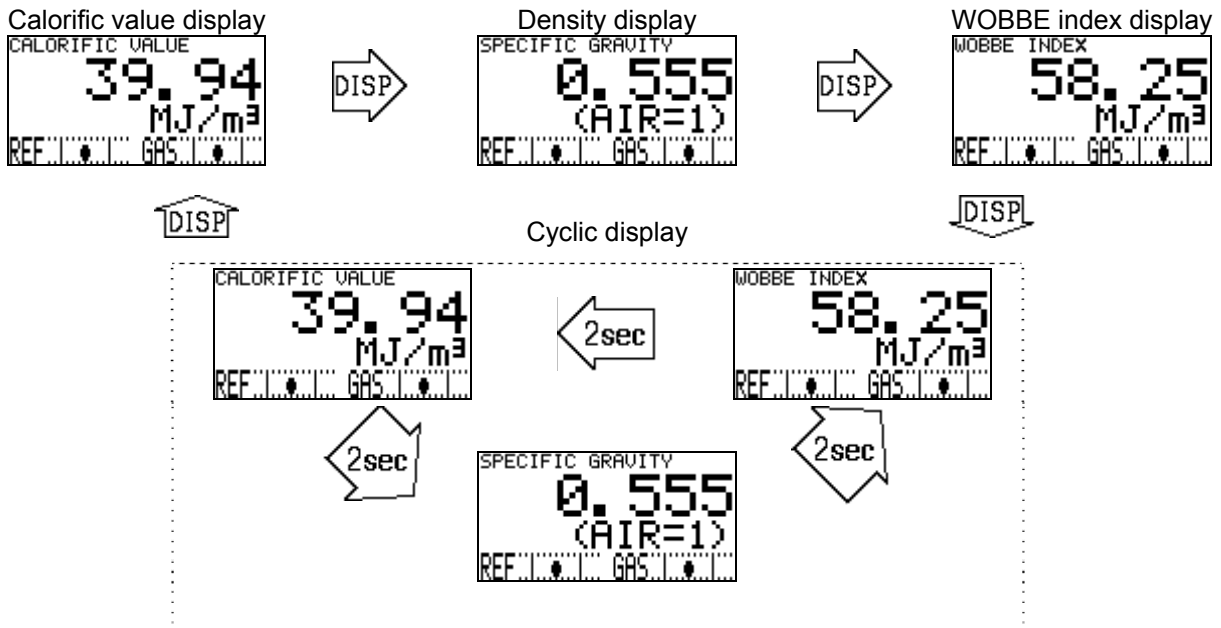

Although this operation changes the information displayed on the LCD, it is not reflected on 4 - 20 mA output signals.

4 - 20 mA signal output conditions can be set as described in Section 6.2.3, "4 - 20 mA condition settings," for which one of "Calorific value," "Density," and "WOBBE index" can be selected.

Related sections	5.2.6, "Check of 4 - 20 mA settings" 6.2.3, "4 - 20 mA condition settings"
------------------	---

4-3. Switching to other mode

During measurement, press and hold the MODE key for three seconds or longer to display the MODE CHANGE screen.

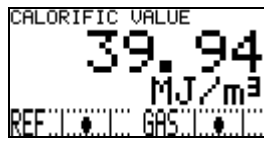

MEASURING MODE screen

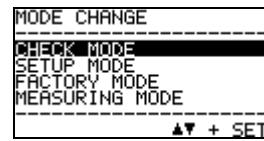
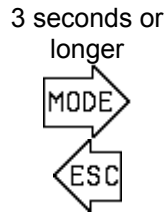

MODE CHANGE screen

In this MODE CHANGE screen, move the cursor (black bar) using the ▲▼ keys to select a desired mode and confirm it using the SET key to enter each mode.

The screen and details of each mode are shown in the table below.

Mode	Screen	Details
CHECK MODE		Used to display or check the operation status or setting conditions of each unit while continuing measurement. In this mode, 4 - 20 mA signals are output without stopping measurement.
SETUP MODE		Used to specify the settings of the calorimeter such as how to calculate "Calorific value" and "Density" and the condition settings for 4 - 20 mA output signals. Prompts the user for password input because measurement is stopped in this mode.
FACTORY MODE		Used for factory adjustment, maintenance, or start-up. This mode is for exclusive use by RIKEN KEIKI and service engineer designated by RIKEN KEIKI, and normally must not be operated by the user. Prompts the user for password input because measurement is stopped in this mode.
MEASURING MODE		Used to return to the normal MEASURING MODE screen.

4-4. Self-diagnostic function

The OHC-800, having an advanced self-monitoring/diagnostic function compliant with NAMUR NE107 (self-monitoring/diagnostic of field devices), performs real-time self-diagnostic and monitoring for devices classifying the state into four categories shown below.

The table below shows the categories, screens, and state explanation of the device.

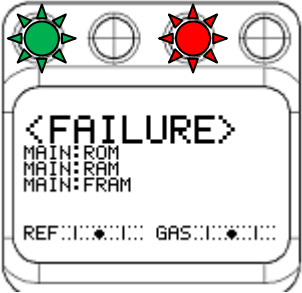
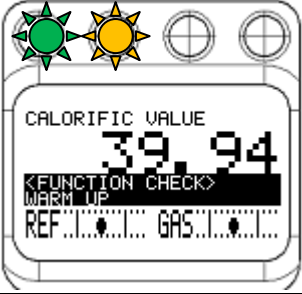
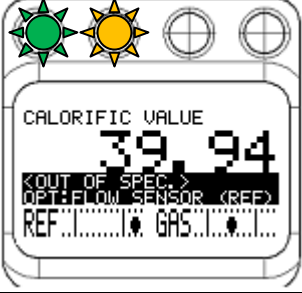
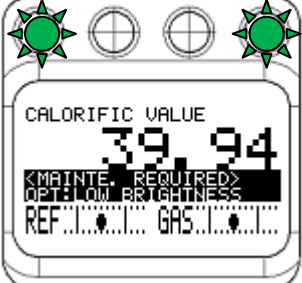
Category	Screen	State explanation
FAILURE		<p>An abnormality occurred inside or outside the device, and the measuring result and output signal are not valid.</p> <p>Contact Output 2 is activated, and the EV2 lamp (red) lights up. 4 - 20 mA signals are output according to the setting value specified by the user. (See Section 6.2.3, "4 - 20 mA condition settings (4 - 20 mA SETTINGS).")</p>
FUNCTION CHECK		<p>Although the device is normal, measurement is stopped due to the operation of the check function etc.</p> <p>Contact Output 1 is activated, and the EV1 lamp (orange) lights up. 4 - 20 mA signals are output according to the setting value specified by the user. (See Section 6.2.3, "4 - 20 mA condition settings (4 - 20 mA SETTINGS).")</p>
OUT OF SPECIFICATION		<p>Although the device is normal and measurement is continued, an out-of-specifications condition is detected, deteriorating the reliability of measuring results and output signals.</p> <p>Contact Output 1 is activated, and the EV1 lamp (orange) lights up. 4 - 20 mA signals are output as measuring results.</p>
MAINTENANCE REQUIRED		<p>Although the device is normal and valid measurement is continued, the calorimeter has detected the progress of a certain deterioration and is requesting for maintenance.</p> <p>Contact Output 3 is activated, and the EV3 lamp (green) lights up. 4 - 20 mA signals are output as measuring results.</p>

The contact output and EV lamp operation settings can be changed using the SETUP MODE as described in Section 6.2.8, "Display and contact operation settings (DISP. & CONTACT SETTINGS)."

4-5. Operations of contacts, display, and signal output after recovery to normal state

This section describes how the OHC-800 operates when it detects one of the state categories shown below using the self-diagnostic/monitoring function and returns to a normal state by itself.

- FAILURE
- OUT OF SPECIFICATION
- MAINTENANCE REQUIRED

In the standard setting of the OHC-800, the operations of the contacts, LCD display screen, and 4 - 20 mA signal output are as described below.

<Contact activation>

The contacts are self-latched, and the contact state is maintained after state recovery. To reset the contact state, enter the CHECK MODE and do as described in Section 5.2.13, "Latching reset for display and contact (LATCHING RESET (DISP. & CONTACT))."

<LCD display screen>

After state recovery, the calorimeter enters the "Trace display" state, in which the display screen corresponding to the category that has occurred and the display screen for normal measurement are displayed in turn.

To reset this display state, enter the CHECK MODE and do as described in Section 5.2.13, "Latching reset for display and contact (LATCHING RESET (DISP. & CONTACT))."

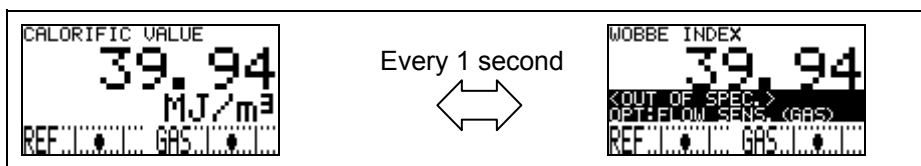

Operation of "Trace display"

<4 - 20 mA signal>

4 - 20 mA signal is self-reset after state recovery, and normal measuring results are output.

Related sections	5.2.12, "Check of display and contact settings (DISP. & CONTACT PARAMETER)" 6.2.8, "Display and contact operation settings (DISP. & CONTACT SETTINGS)"
------------------	---

* Turning off and on the power resets all of the contact latching states and the LCD "Trace display" operations.

5

How to Operate in Check Mode

The CHECK MODE is used to display or check the operation status or setting conditions of each unit while continuing measurement. In this mode, 4 - 20 mA signals are output as measuring results without stopping measurement.

To enter CHECK MODE, display the MODE CHANGE screen while in MEASURING MODE, move the cursor (black bar) using the ▲▼ keys, select "CHECK MODE," and confirm it using the SET key. This operation displays the menu screen of CHECK MODE. (See Section 4.3, "Switching to other mode.")

In the menu screen of CHECK MODE, press and hold the ESC key for three seconds or more to return to the MEASURING MODE.

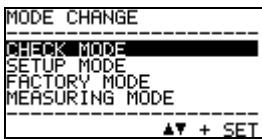

MODE CHANGE screen

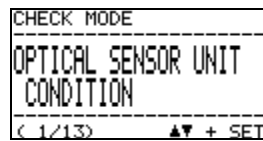

Menu screen



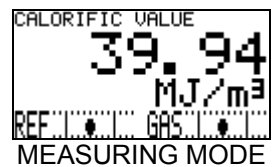



3 seconds or longer

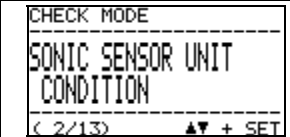

MEASURING MODE

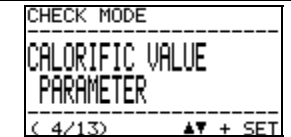
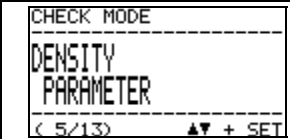
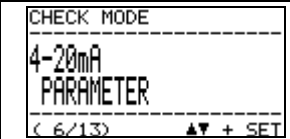
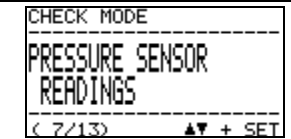
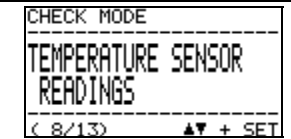
5-1. Menu items of CHECK MODE

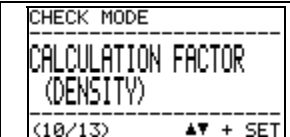
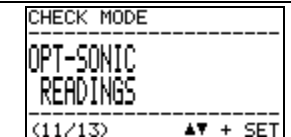
The menu items that can be selected in CHECK MODE are shown in the table below.

			
Display the state of the optical sensor unit.	Display the state of the sonic sensor unit.	Display the state of the main controller.	Display the measuring conditions for calorific value.
			
Display the measuring conditions for density.	Display 4 - 20 mA setting.	Display the pressure sensor output.	Display the temperature sensor output.
			
Display the setting of the calorific value calculation.	Display the setting of the density calculation.	Display the Opt-Sonic calculation process.	Display the setting of the display and contacts.
			
Reset the latching of the display and contacts.			

5-2. Items and details

In the menu screen of CHECK MODE, select the desired item using the ▲▼ keys and confirm it using the SET key to display the detailed information for the item. This section describes the detailed information displayed for the items.

5-2-1. Check of optical sensor unit state (OPTICAL SENSOR UNIT CONDITION)

This screen displays the program information for the optical sensor unit, the self-diagnostic results measured inside the unit etc. in turn.



Menu screen

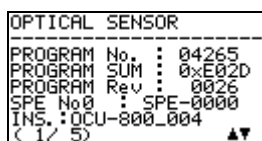
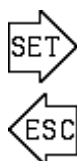

Displays the program number, SUM number, Rev number, SPE number, serial number etc.

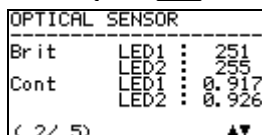
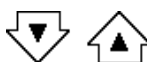

Displays the brightness and contrast of interference fringes for each of LED1 and LED2.

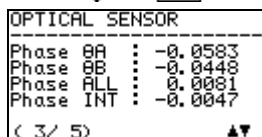
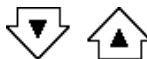

Displays the information on the phases of interference fringes.

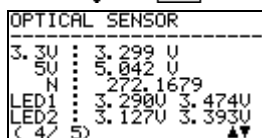
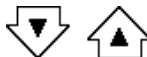

Displays the information on the optical sensor unit, i.e., used power voltages, refractive index measuring results, and driving voltages of LED1 and LED2.

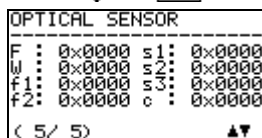

Displays the self-diagnostic flags managed inside the optical sensor.

5-2-2. Check of sonic sensor unit state (SONIC SENSOR UNIT CONDITION)

This screen displays the program information for the sonic sensor unit, the self-diagnostic results measured inside the unit etc.

```

CHECK MODE
-----
SONIC SENSOR UNIT
CONDITION
-----
< 2/13 >      ▲▼ + SET
    
```

Menu screen

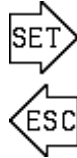

```

SONIC SENSOR
-----
PROGRAM No. : 00010
PROGRAM SUM : 0x3A85
INS. : US-SP-0030
-----
< 1/ 2 >      ▲▼
    
```

Displays the program number, SUM number, and serial number.

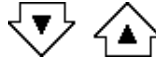

```

SONIC SENSOR
-----
Time T: 384.15µsec
C.U. H: 58.803 MJ/m³
FAIL FLG : 0x0000
WARN FLG : 0x0000
-----
< 2/ 2 >      ▲▼
    
```

Displays the time in which sound arrives, standardized signal, and self-diagnostic flags (failure and warning flags).

5-2-3. Check of main controller state (MAIN CONTROLLER CONDITION)

This screen displays the program information for the main controller, the self-diagnostic results measured inside the controller etc.

```

CHECK MODE
-----
MAIN CONTROLLER
CONDITION
-----
< 3/13 >      ▲▼ + SET
    
```

Menu screen

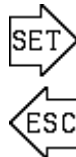

```

MAIN CONTROLLER
-----
PROGRAM No. : 04264
PROGRAM SUM : 0xA3B7
PROGRAM Rev : 0049
SPE No. : SPE-0000
INS. : OHC-800 DEBUG-01
-----
< 1/ 4 >      ▲▼
    
```

Displays the program number, SUM number, Rev number, SPE number, serial number etc.

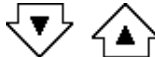

```

MAIN CONTROLLER
-----
3.3V : 3.300 V
5V : 5.074 V
24V : 23.911 V
4-20mA: 4.021 mA
-----
< 2/ 4 >      ▲▼
    
```

Displays the voltages of the power supply systems (3.3 V, 5 V, and 24 V systems). Display the output state of 4 - 20 mA signal.

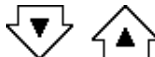

```

MAIN CONTROLLER
-----
F : 0x0000 s1: 0x0000
S : 0x0000 s2: 0x0000
MC: 0x0000 s3: 0x0000
F1: 0x0000 c : 0x0000
F2: 0x0000
-----
< 3/ 4 >      ▲▼
    
```

Displays the various self-diagnostic flags monitored inside the main controller.

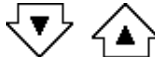

```

MAIN CONTROLLER
-----
LANGUAGE: ENGLISH
-----
< 4/ 4 >      ▲▼
    
```

Displays the language used for "CAUTION screen."

5-2-4. Check of measuring conditions for calorific value (CALORIFIC VALUE PARAMETER)

This screen displays the "unit," "calorific value type," "standard temperature," "standard pressure," and "offset value" to be used for calorimetry.

The "offset value" can be changed using the SETUP MODE as described in Section 6.2.7, "Offset (OFFSET ADJUSTMENT)." Contact RIKEN KEIKI if other item settings need to be changed.

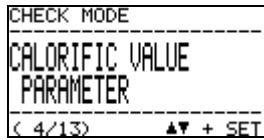

Menu screen

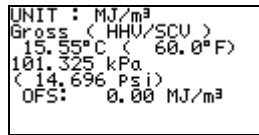
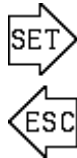

Unit of calorimetry
Calorific value type
Standard temperature
Standard pressure
Calorific value offset

5-2-5. Check of measuring conditions for density (DENSITY PARAMETER)

This screen displays the "unit," "standard pressure," "standard temperature," and "offset value" to be used for densimetry.

The "offset value" can be changed using the SETUP MODE as described in Section 6.2.7, "Offset (OFFSET ADJUSTMENT)." Contact RIKEN KEIKI if other item settings need to be changed.

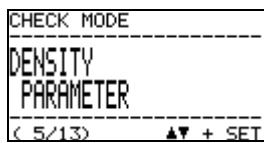

Menu screen

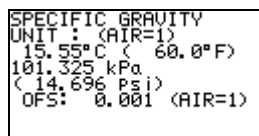
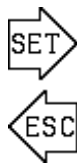

Unit of densimetry
Standard temperature
Standard pressure
Density offset

5-2-6. Check of 4 - 20 mA settings (4 - 20 mA PARAMETER)

This screen displays the "output item" and "output range" to be output in 4 - 20 mA signal.

It also displays the settings of 4 - 20 mA signal for a FAILURE or FUNCTION CHECK. (* HOLD MEASURED VALUE means that the last measured value is held and output.)

The figure below shows that the output item is set to "CALORIFIC VALUE" and the output range to "36.00 to 46.00 MJ/m³" and that the output item is fixed to 0.50 mA for FAILURE and the last measured value is held and output for FUNCTION CHECK.



Menu screen

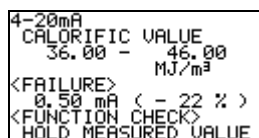
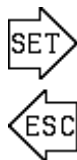

Output item
Output range
4 - 20 mA setting for FAILURE
4 - 20 mA setting for FUNCTION CHECK

Note that 20 mA is output if the detected result exceeds the upper limit of the output range setting and that 4 mA is output if it falls below the lower limit.

5-2-7. Check of pressure sensor output (PRESSURE SENSOR READINGS)

This screen displays the output of three pressure sensors installed in the optical sensor unit.

- P (GAS): Output of the micro-differential pressure sensor that detects the flow rate of measuring gas supplied to the OHC-800.
- P (REF): Output of the micro-differential pressure sensor that detects the flow rate of REF gas supplied to the OHC-800.
- P (OUT): Output of the absolute pressure sensor at GAS OUT of the OHC-800 to be used for pressure correction.

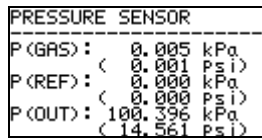
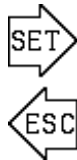
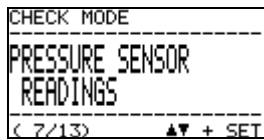

- Output value of GAS differential pressure sensor
- Output value of REF differential pressure sensor
- Output value of OUT absolute pressure sensor

Menu screen

5-2-8. Check of temperature sensor output (TEMPERATURE SENSOR READINGS)

This screen displays the output of temperature sensors installed in the main controller, optical sensor unit, and sonic sensor unit.

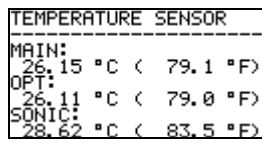
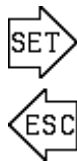
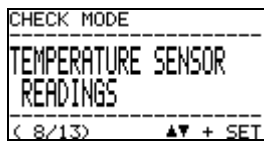

- Output value of temperature sensor on main PCB
- Output value of temperature sensor on optical sensor unit
- Output value of temperature sensor on sonic sensor unit

Menu screen

5-2-9. Check of calorific value calculation settings (CALCULATION FACTOR (CALORIFIC VALUE))

This screen displays the setting of the calorific value calculation type. The following three types of calorific value calculation are available.

- OPT-SONIC CALCULATION: Calculate the calorific value using a combination of the optical and sonic sensors.
 OPTICAL SENSOR: Calculate the calorific value using only the optical sensor.
 SONIC SENSOR: Calculate the calorific value using only the sonic sensor.

For information on the differences of these types and change of settings, see the SETUP MODE described in Section 6.2.1, "Setting of calorific value calculation conditions (CALCULATION FACTOR (CALORIFIC VALUE))."

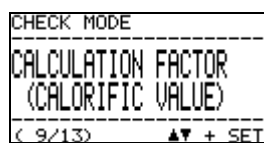

Menu screen

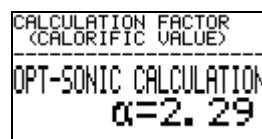
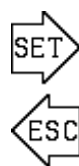

If OPT-SONIC CALCULATION is selected, the calculation factor α is displayed.

5-2-10. Check of density calculation settings (CALCULATION FACTOR (DENSITY))

This screen displays the setting of the density calculation type. The following three types of density calculation are available.

- OPT-SONIC CALCULATION: Calculate the density using a combination of the optical and sonic sensors.
 OPTICAL SENSOR: Calculate the density using only the optical sensor.
 SONIC SENSOR: Calculate the density using only the sonic sensor.

For information on the differences of these types and change of settings, see the SETUP MODE described in Section 6.2.2, "Setting of density calculation conditions (CALCULATION FACTOR (DENSITY))."

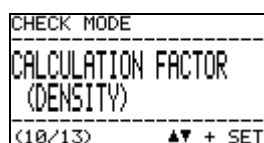

Menu screen

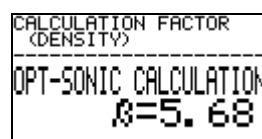

If OPT-SONIC CALCULATION is selected, the calculation factor β is displayed.

5-2-11. Check of Opt-Sonic calculation process (OPT-SONIC READINGS)

This screen displays the interim result of the Opt-Sonic calculation.

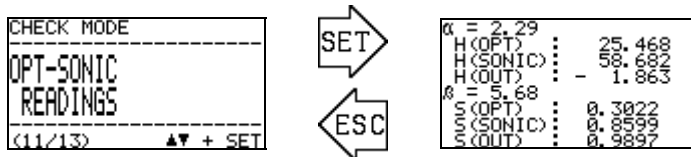

Menu screen

The items to be displayed are as shown below.

Symbol	Meaning of symbol
α	Factor used in the calorific value calculation of Opt-Sonic calculation
H(OPT)	Calorific value measured using only the optical sensor
H(SONIC)	Calorific value measured using only the sonic sensor
H(OUT)	Result obtained using the method selected in the "calorific value calculation setting"
β	Factor used in the density calculation of Opt-Sonic calculation
S(OPT)	Density measured using only the optical sensor (converted to specific gravity)
S(SONIC)	Density measured using only the sonic sensor (converted to specific gravity)
S(OUT)	Result obtained using the method selected in the "density calculation setting"

Regardless of the settings of the product, this screen displays a calorific value converted to MJ/m³, Gross, 0°C, and 101.325 kPa and a density converted to a specific gravity (AIR=1), respectively.

5-2-12. Check of display and contact settings (DISP. & CONTACT PARAMETER)

This screen displays how the LCD display and contacts operate according to the conditions applied when the OHC-800 detects either of the FAILURE, FUNCTION CHECK, OUT OF SPECIFICATION, and MAINTENANCE REQUIRED states.

In the menu screen, press the SET key to display the list of conditions of the self-diagnostic/monitoring function. Using the ▲▼ keys, select a condition and press the SET key to display the LCD display and contact operations when the selected condition is detected.

For information on how to change the settings and available operations, see the SETUP MODE described in Section 6.2.8, "Setting of display and contact operations (DISP. & CONTACT SETTINGS)."

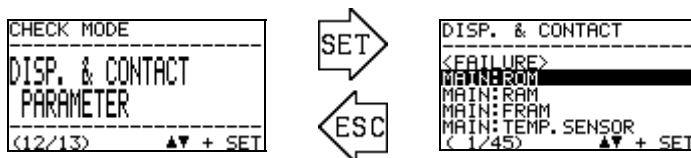

Menu screen

The self-diagnostic conditions are displayed. Select an item using ▲▼ keys and press the SET key to check the details.



The details of LCD display and contact operation under the self-diagnostic conditions are displayed.

5-2-13. Latching reset for display and contact (LATCHING RESET (DISP. & CONTACT))

- FAILURE
- OUT OF SPECIFICATION
- MAINTENANCE REQUIRED

If the OHC-800 detects one of the state categories shown above using the self-diagnostic/monitoring function and returns to a normal state by itself, the contact is self-latched and the LCD display screen enters the "Trace display" state in its standard settings. (See Section 4.5, "Operations of contacts, display, and signal output after recovery to normal state.")

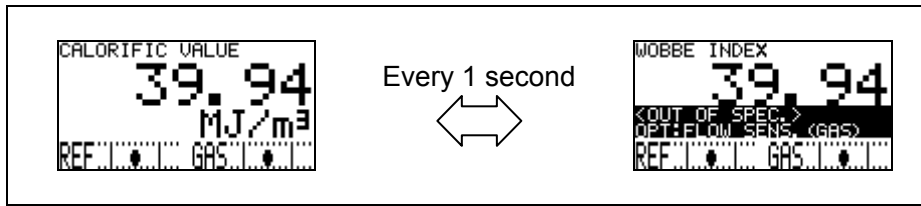

Operation of "Trace display"

This menu item is used to reset the self-latch state of the contacts and the "Trace display" state of the LCD display.

In the menu screen, press the SET key to display the CAUTION screen informing that the latching states of the display screen and contacts will be reset.

When "OK" is selected using the ▲▼ + SET keys, the states of the contacts and LCD are reset, and the ordinary measurement screen and the normal contact operation are resumed.

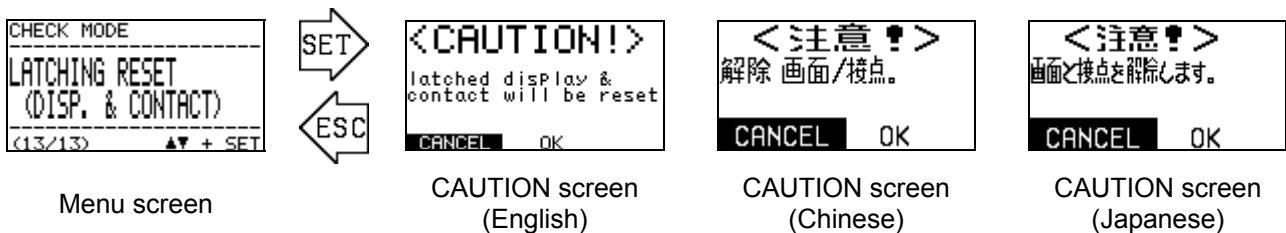

Menu screen

CAUTION screen (English)

CAUTION screen (Chinese)

CAUTION screen (Japanese)

6

How to Operate in SETUP MODE

SETUP MODE is used to set how to calculate calorific value and density, output conditions for 4 - 20 mA signals, operating conditions of the contacts, etc with the OHC-800. In this mode, the calorimeter stops measurement, enters the "FUNCTION CHECK" state, and outputs 4 - 20 signals according to the user-specified conditions. (For information on changing the output conditions, see Section 6.2.3, "4 - 20 mA condition settings (4 - 20 mA SETTINGS).")

To enter SETUP MODE, display the MODE CHANGE screen while in MEASURING MODE, move the cursor (black bar) using the ▲▼ keys, select "SETUP MODE," and press the SET key to confirm it. Then, the password input screen is displayed, so enter the password (one character after another) using the ▲▼ + SET keys.

The password is factory-set to "00000." For information on how to change the password, see the SETUP MODE described in Section 6.2.13, "Password change (PASSWORD SETUP (SETUP MODE))."

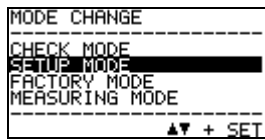

MODE CHANGE screen

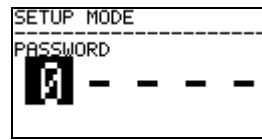

Password input screen

When a correct password is entered, the "CAUTION screen" is displayed to inform that measurement will be stopped.

When "OK" is selected using the ▲▼ + SET keys, measurement is stopped, and the menu screen for the SETUP MODE is displayed.

In the menu screen of SETUP MODE, press and hold the ESC key for three seconds or more to return to the MEASURING MODE.



CAUTION screen (English)



CAUTION screen (Chinese)



CAUTION screen (Japanese)

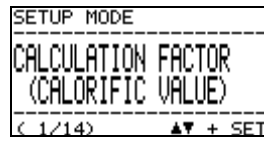

Menu screen



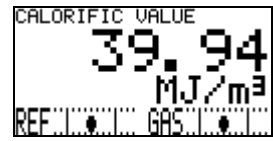

3 seconds or longer

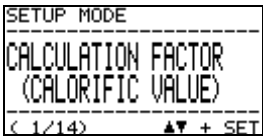
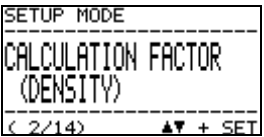
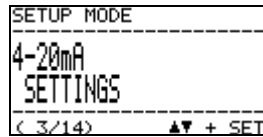
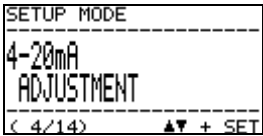
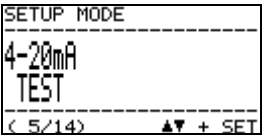
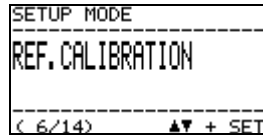
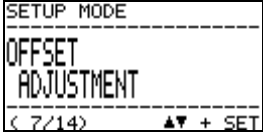

MEASURING MODE

6-1. SETUP MODE items

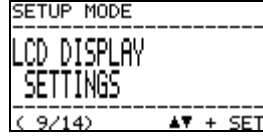
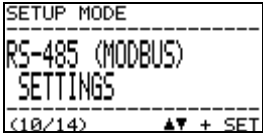
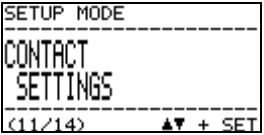
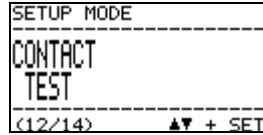
In the SETUP MODE, the menu items shown in the table below can be used.

 <p>Setting of calorific value calculation conditions</p>	 <p>Setting of density calculation conditions</p>	 <p>Setting of 4 - 20 mA conditions</p>
<p>Set the detailed conditions for calorific value calculation such as sonic sensor measurement, optical sensor measurement, and Opt-Sonic calculation.</p>	<p>Set the detailed conditions for density calculation such as sonic sensor measurement, optical sensor measurement, and Opt-Sonic calculation.</p>	<p>Set the details of information to be output in 4 - 20 mA signals.</p>
 <p>4 - 20 mA output adjustment</p>	 <p>4 - 20 mA output test</p>	 <p>Reference calibration</p>
<p>Adjust 4 - 20 mA signal output level.</p>	<p>Output an arbitrary test signal for 4 - 20 mA signals.</p>	<p>Perform reference calibration. Reference calibration is operation for adjusting the reference point of the optical sensor unit.</p>
 <p>Offset</p>	 <p>Display/contact operation settings</p>	 <p>Change of LCD display settings</p>
<p>Adjust the offset value to be added to or subtracted from the measuring results of calorific value or density.</p>	<p>Set the details of display and contact operations when detecting a certain condition using the self-diagnostic function.</p>	<p>Set the contrast of LCD display and brightness of backlight.</p>
 <p>Change of RS-485 (MODBUS) communication settings</p>	 <p>Change of energized contact settings</p>	 <p>Check the contact operation</p>
<p>Set the RS-485 (MODBUS) communication conditions.</p>	<p>Set the energized contact conditions for Contact Outputs 1 through 3.</p>	<p>Output an arbitrary test signal for contact signal.</p>
 <p>Password change</p>	 <p>Log data download</p>	
<p>Change the password required to enter SETUP MODE.</p>	<p>Download the log data using IrDA.</p>	



6-2. Items and details

6-2-1. Setting of calorific value calculation conditions (CALCULATION FACTOR (CALORIFIC VALUE))

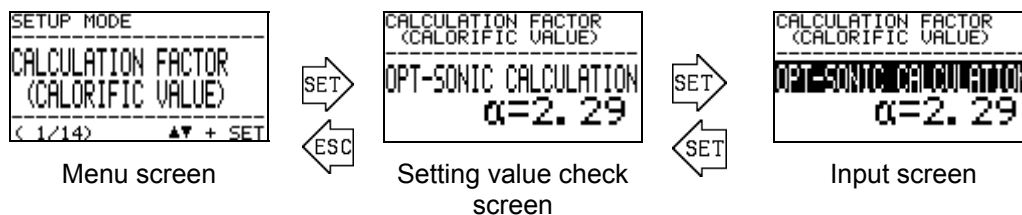
Set the calorific value calculation conditions. In the menu screen, press the SET key to display the setting value check screen and display the current settings of calculation conditions. Next, press the SET key to highlight the line indicating the calculation method in reverse video and enable selection of a calculation method using the ▲▼ + SET keys.



The figures above are examples in which Opt-Sonic calculation is set. The available calculation methods and characteristics are shown in the table below.

 <p>Opt-Sonic calculation</p>	<p>This method effectively suppresses the influences of interference gases on the measuring results of the optical and sonic sensors through calculation processing. The calculation factor α must be set according to the major fluctuating components of interference gases.</p>
 <p>Optical sensor calculation</p>	<p>This method calculates calorific values using only the optical sensor. The calorific value measurement using only the optical sensor is relatively less influenced by interference gases. Therefore, this method can also be used for measurement if there is a small amount of interference gases.</p>
 <p>Sonic sensor calculation</p>	<p>This method calculates calorific values using only the sonic sensor. The calorific value measurement using only the sonic sensor is significantly influenced by interference gases. Therefore, this method is not recommended unless there are unavoidable circumstances.</p>

After "OPT-SONIC CALCULATION" is selected as the calorific value calculation method, the calculation factor α setting screen is displayed. Set a numeric value using the ▲▼ keys, and confirm the value using the SET key.

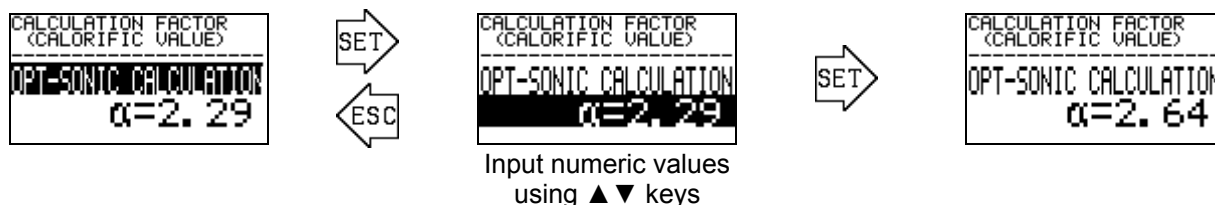

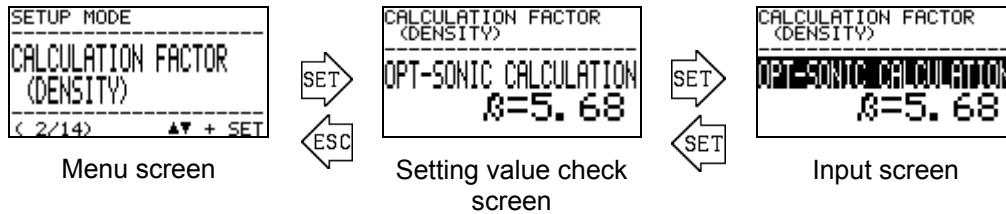

6-2-2. Setting of density calculation conditions (CALCULATION FACTOR (DENSITY))

Set the density calculation conditions. In the menu screen, press the SET key to display the setting value check screen and display the current settings of calculation conditions. Next, press the SET key to highlight the line indicating the calculation method in reverse video and enable selection and confirmation of a calculation method using the ▲▼ + SET keys.

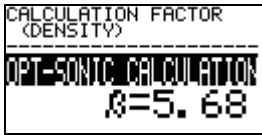
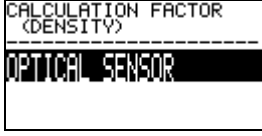

The figures above are examples in which Opt-Sonic calculation is set. The available calculation methods and characteristics are shown in the table below.

 <p>Opt-Sonic calculation</p>	<p>This method effectively suppresses the influences of interference gases on the measuring results of the optical and sonic sensors through calculation processing. The calculation factor β must be set according to the major fluctuating components of interference gases.</p>
 <p>Optical sensor calculation</p>	<p>This method calculates density using only the optical sensor. The density measurement using only the optical sensor is significantly influenced by interference gases. Therefore, this method is not recommended unless there are unavoidable circumstances.</p>
 <p>Sonic sensor calculation</p>	<p>This method calculates density using only the sonic sensor. The density measurement using only the sonic sensor is relatively less influenced by interference gases. Therefore, this method can also be used for measurement if there is a small amount of interference gases.</p>

When "OPT-SONIC CALCULATION" is selected as the density calculation method, the calculation factor β setting screen is displayed. Set a numeric value using the ▲▼ keys, and confirm the value using the SET key.

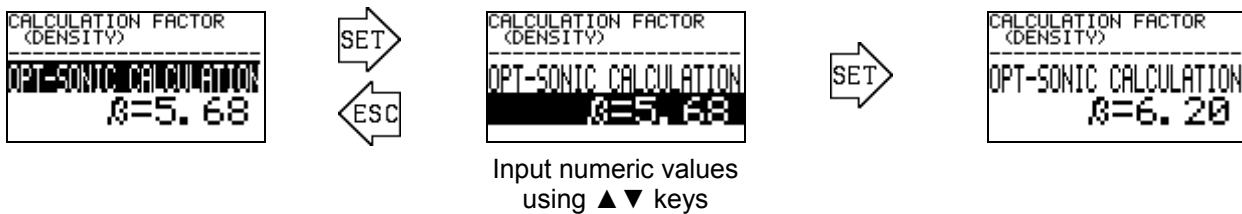

6-2-3. 4 – 20 mA condition settings (4 – 20 mA SETTINGS)

Display the output conditions of 4 - 20 mA signal. In the menu screen, press the SET key to display the setting value check screen and display the current settings of 4 - 20 mA conditions.

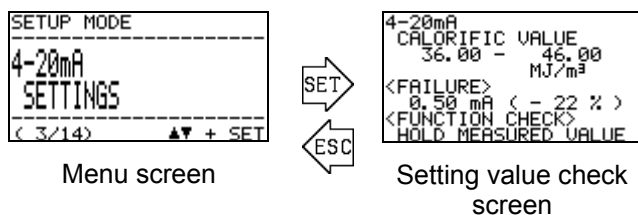

The example above shows the screens displayed when "CALORIFIC VALUE" is the selected output item, and the 36.00 to 46.00 MJ/m³ range is the output range setting of 4 - 20 mA signals.

When the SET key is pressed in the setting value check screen, the "CAUTION screen" is displayed to inform that 4 - 20 mA output signal will be changed.



When "OK" is selected using the ▲▼+SET keys, and the setting screen appears. As shown in the figure below, use the ▲▼ and SET keys to specify the output item, upper and lower limits of the output range, and output values for the FAILURE and FUNCTION CHECK states.

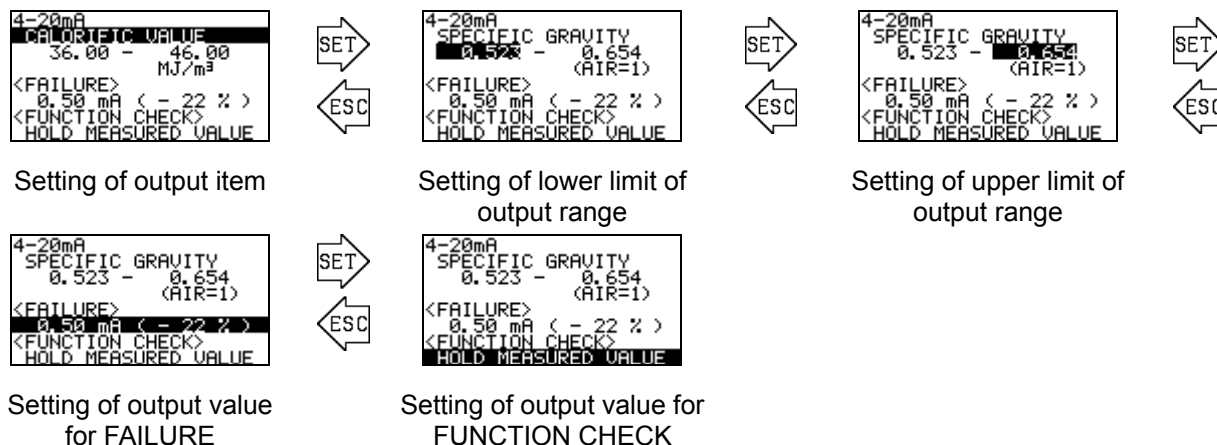

6-2-4. 4 – 20 mA output adjustment (4 – 20 mA ADJUSTMENT)

Adjust 4 - 20 mA signal output level. When the SET key is pressed in the menu screen, the "CAUTION screen" is displayed to inform that 4 - 20 mA output signal will be changed.

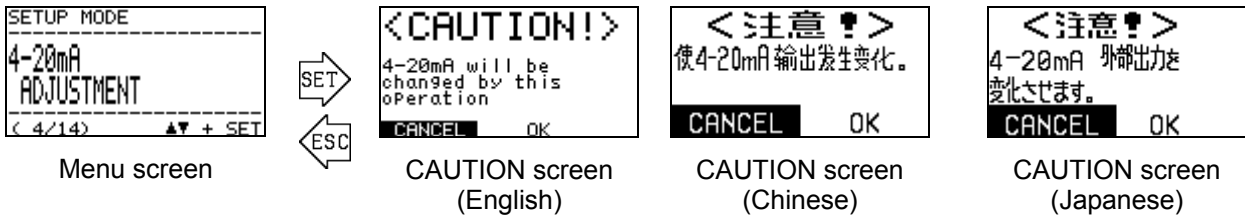

When "OK" is selected using the ▲▼+SET keys, the test signal output screen appears, and a 4 mA or 20 mA test signal is output.

Using the ▲▼ keys, select one of the test signals to output and press the SET key to highlight the line indicating the PWM value in reverse video and enable selection of an output level. Using the ▲▼ keys, change the PWM value to adjust the output level, and press the SET key to confirm it.

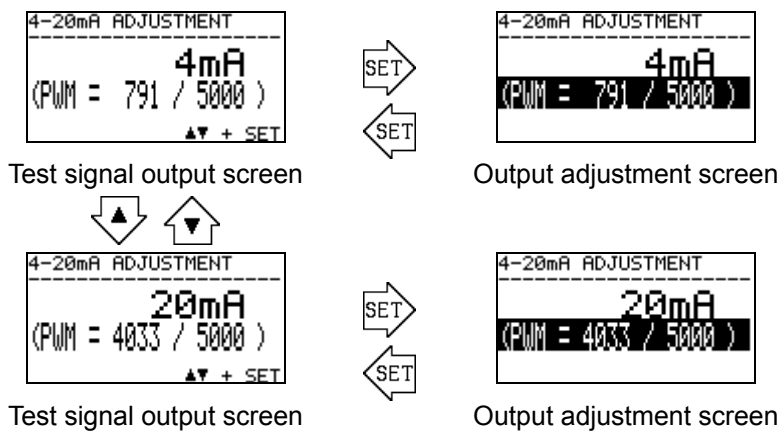

Press the ESC key to finish adjustment and return to the menu screen. 4 - 20 mA output value returns to the state before the output test.

6-2-5. 4 – 20 mA output test (4 – 20 mA TEST)

This screen is used to output an arbitrary test signal for 4 - 20 mA signals. When the SET key is pressed in the menu screen, the "CAUTION screen" is displayed to inform that 4 - 20 mA output signal will be changed.



When "OK" is selected using the ▲▼ + SET keys, the 4 mA test signal is output.

Further press the ▲▼ keys to change the test signal from 0.50 to 22.00 mA in steps of 0.05 mA.

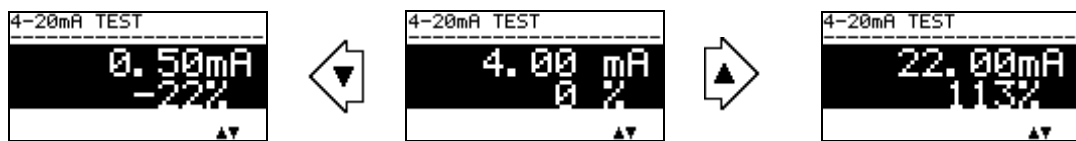

Press the ESC key to finish output test and return to the menu screen. 4 - 20 mA output value returns to the state before the output test.

6-2-6. Reference calibration (REF. CALIBRATION)

Perform reference calibration if there is a deviation in the reference point for measurement by the optical sensor unit.

In the menu screen, press the SET key to display the reference calibration check screen.

NOTE

A sufficient amount of reference gas must be supplied from the measuring gas IN of the calorimeter to perform reference calibration.

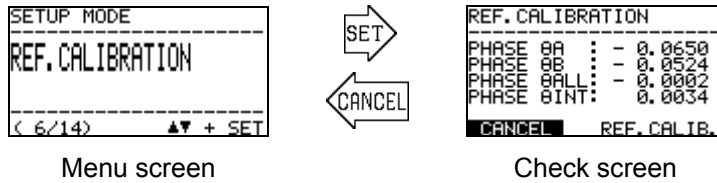

In this state, supply a sufficient amount of reference gas from the OHC-800 measuring gas IN to check the PHASE θ_{ALL} value. Reference gas calibration is not needed if the PHASE θ_{ALL} value is near 0 (e.g., ± 0.0100 or less).

To perform reference gas calibration, select REF.CALIB. using the ▲▼ keys and confirm it using the SET key.



When calibration is completed in about three seconds, the check screen appears again. Check that the PHASE θ_{ALL} value is near 0 (e.g. ± 0.0100 or less).

Press the ESC key or select CANCEL to end the operation.

6-2-7. Offset (OFFSET ADJUSTMENT)

Adjust the offset value to be added to or subtracted from the measuring results of calorific value or density. Use this function if there is a difference between the measuring results of the OHC-800 and those of the calorimeter/densimeter that the user uses as the criteria or those of the standard gas.

In the menu screen, press the SET key to display the setting value check screen and display the current settings of offset values. Next, press the SET key to display the input screen and enter and confirm the offset values for the calorific value and density in turn using the ▲▼ and SET keys.

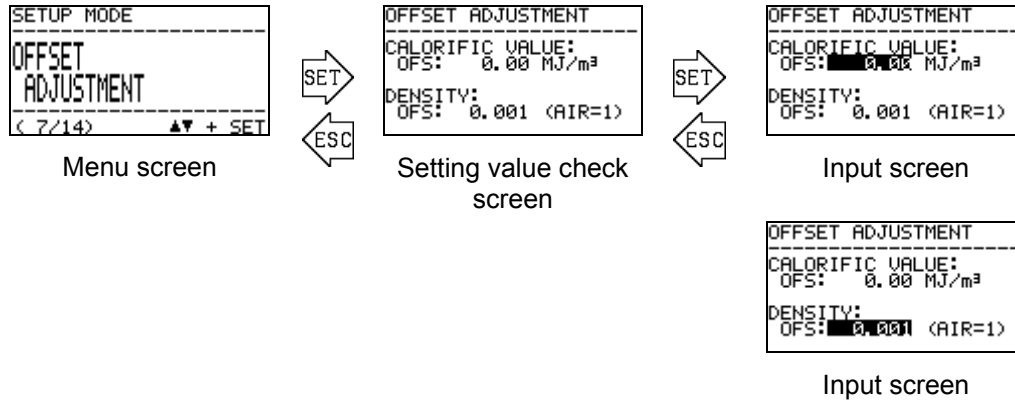

6-2-8. Display and contact operation settings (DISP. & CONTACT SETTINGS)

Set the operations of LCD display and contacts in detail according to the conditions applied when the self-diagnostic/monitoring function detects either of the FAILURE, FUNCTION CHECK, OUT OF SPECIFICATION, and MAINTENANCE REQUIRED states.

In the menu screen, press the SET key to display the list of conditions of the self-diagnostic/monitoring function.

Using the ▲▼ keys, select a condition and press the SET key to display the details screen, which displays the LCD display and contact operations that occur when the selected condition is detected.

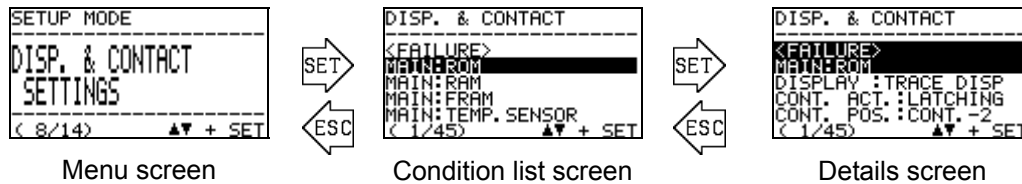

In the details screen, press the SET key to highlight an item to be changed in reverse video. Using the ▲▼ keys, select an operation and confirm it using the SET key. The table below shows the operations that can be selected for the items.

Item to be changed	Available operation	Description
<div style="border: 1px solid black; padding: 5px; font-size: 0.8em;"> <pre> DISP. & CONTACT ----- <FAILURE> MAIN:RAM DISPLAY :TRACE DISP CONT. ACT.:LATCHING CONT. POS.:CONT.-2 ----- (1/45) ▲▼ + SET </pre> <p style="text-align: center;">DISPLAY (LCD display operation)</p> </div>	TRACE DISP	After state recovery, displays data in turn to keep the history of the states that occurred.
	AUTO RESET	After state recovery, returns to the normal measurement screen.
	OFF	Data according to the states is not displayed even if any state has occurred.
<div style="border: 1px solid black; padding: 5px; font-size: 0.8em;"> <pre> W DISP. & CONTACT ----- <FAILURE> MAIN:RAM DISPLAY :TRACE DISP CONT. ACT.:LATCHING CONT. POS.:CONT.-2 ----- (1/45) ▲▼ + SET </pre> <p style="text-align: center;">Change of contact operation</p> </div>	LATCHING	Maintains the contact state after state recovery.
	AUTO RESET	Automatically resets the contact state after state recovery.
	OFF	Contacts are not operated even if any state has occurred.
<div style="border: 1px solid black; padding: 5px; font-size: 0.8em;"> <pre> DISP. & CONTACT ----- <FAILURE> MAIN:RAM DISPLAY :TRACE DISP CONT. ACT.:LATCHING CONT. POS.:CONT.-2 ----- (1/45) ▲▼ + SET </pre> <p style="text-align: center;">Change of contact position</p> </div>	CONT.-1	Output to Contact 1.
	CONT.-2	Output to Contact 2.
	CONT.-3	Output to Contact 3.
	OFF	Contacts are not operated even if any state has occurred.

NOTE

The FAILURE screen is not displayed even if an abnormality occurs for an item with DISPLAY turned OFF. Therefore, 4 - 20 mA output value is not set to a FAILURE state as well and the measurement is continued.

6-2-9. LCD display settings (LCD DISPLAY SETTINGS)

Change the contrast setting of LCD display and brightness setting of backlight. In the menu screen, press the SET key to display the setting value check screen and display the current settings of communication conditions.

Next, press the SET key to display the input screen and enter and confirm the contrast and brightness in turn using the ▲ ▼ and SET keys.

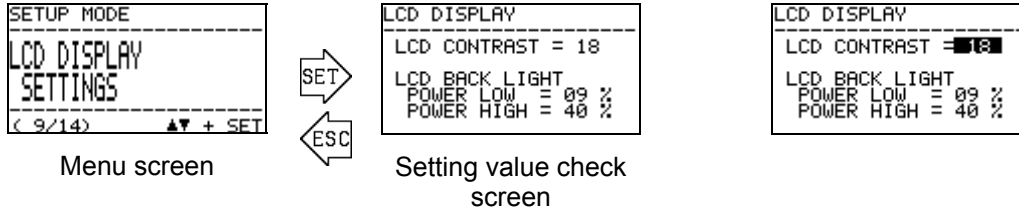

CAUTION

Changing the contrast significantly at once may make the screen entirely white (or entirely black), causing a problem in the operations thereafter. The contrast setting must be changed little by little.

6-2-10. RS-485 (MODBUS) communication settings (RS-485(MODBUS) SETTINGS)

Change the RS-485 (MODBUS) communication settings. In the menu screen, press the SET key to display the setting value check screen and display the current settings of communication conditions. Next, press the SET key to display the input screen and highlight the items in reverse video in turn from the baud rate. Using the ▲▼ and SET keys, select and confirm a condition for each of the items.

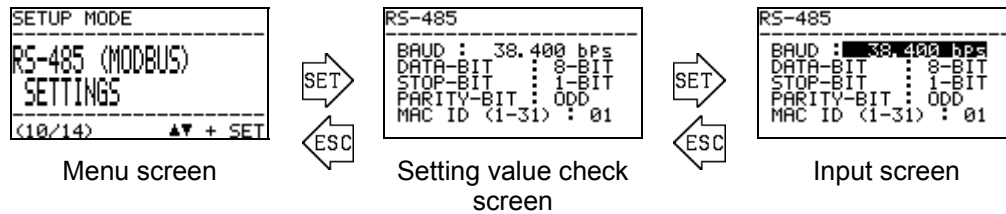

The available value settings for each of the items are as shown below.

	<p>[Baud rate] 4800 bps, 9600 bps, 19200 bps, 38400 bps, 57600 bps, and 115200 bps</p>		<p>[Data bit] 7-BIT and 8-BIT</p>
	<p>[Stop bit] 1-BIT, 2-BIT, ... NONE</p>		<p>[Parity bit] NONE (No parity) IGNORE (Ignore parity) EVEN (Even number), and ODD (Odd number)</p>
	<p>[Machine ID] 1 - 31</p>	<p>Parity bit</p>	

NOTE

If you are considering the use of the RS-485 (MODBUS) communication function, contact RIKEN KEIKI.

6-2-11. Change of energized contact settings (CONTACT SETTINGS)

Change the energized contact settings for Contact Outputs 1 through 3. In the menu screen, press the SET key to display the setting value check screen and display the current settings of energized contacts. Next, press the SET key to display the input screen and highlight one of the energized contact conditions in reverse video in turn, starting from Contact Output 1 (CONT.-1). Using the ▲▼ and SET keys, select and confirm one of the conditions, DE-ENERGIZED (De-energized at all times) and ENERGIZED (Energized at all times).

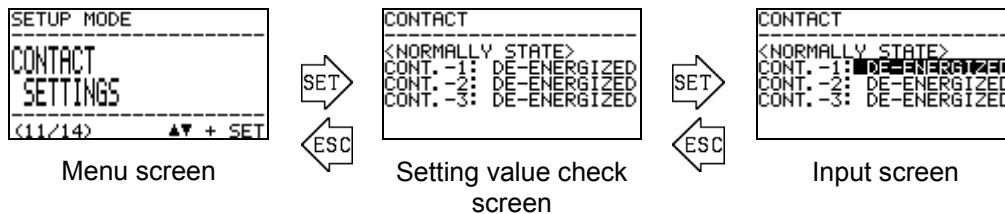

6-2-12. Check the contact operation (CONTACT TEST)

Output an arbitrary test signal for contact signal. In the menu screen, press the SET key to display “CAUTION screen” informing that a contact signal will change.

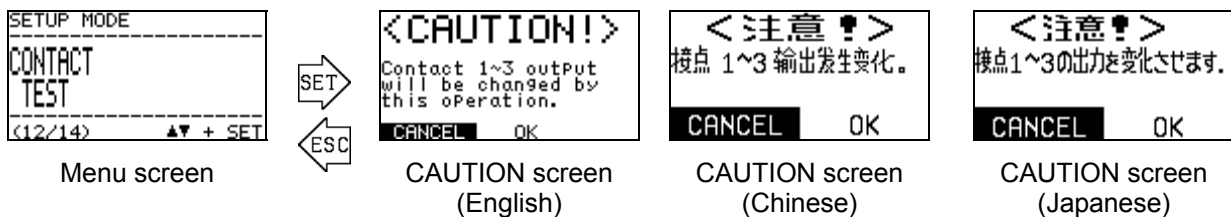

Select the “OK” using ▲▼+SET key to display the test signal output screen, the current contact setting appears, at the same time the test signal of contact signal is delivered. Press the SET key to be in contact select screen, and contact number is displayed inverted. Using the ▲▼ keys to select which test signal to be changed, from contact 1 to contact 3. In addition, press SET key and output change screen, using ▲▼ key to change the contact setting ACTIVE/NORMAL.

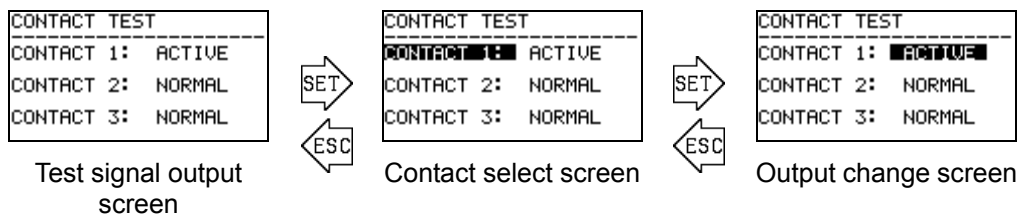

Press the ESC key to finish contact output test and return to the menu screen. Contact output value returns to the state before the output test.

6-2-13. Password change (PASSWORD SETUP (SETUP MODE))

Change the password required to enter SETUP MODE. In the menu screen, press the SET key to display the setting value check screen and display the current password setting. Next, press the SET key to display the password input screen and enter characters 0 to 9 and A to F one by one using the ▲▼ and SET keys.

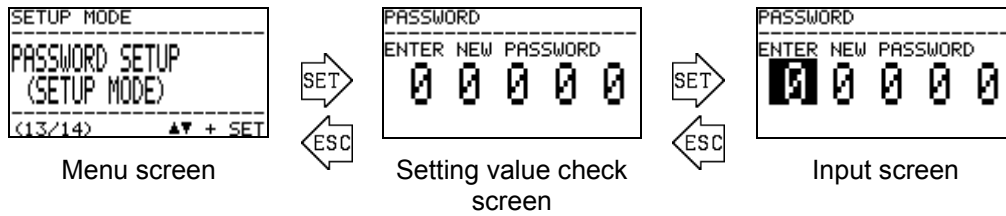

CAUTION

Note that you cannot enter the SETUP MODE without the password specified here. If you forget the password, contact RIKEN KEIKI.

6-2-14. Log data download (IrDA COMMUNICATION)

Using IrDA, and perform downloading log data. When enter into this screen, data logging function stops temporarily. In the menu screen, press the SET key to display the STANDBY screen. The timing is off, display the CAUTION screen as the following screen. During the log data writing, it cannot download. Perform 10 to 30 seconds later, again.

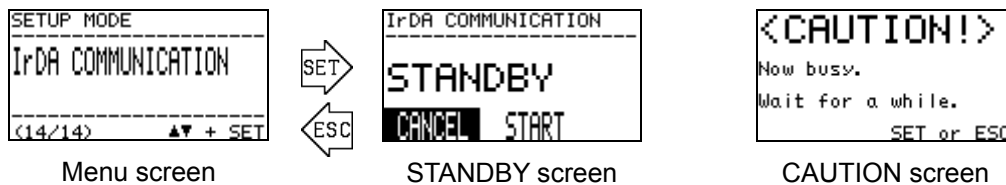

Prepare for a communication equipment (GX-2009 TYPE-DL etc.) in STANDBY screen state. After start communicating in communication device, select the START using ▲▼ key, and press SET key. If communications establish normally, it is to be data transmission screen automatically and answer to request-to-send from communication device. When communications do not establish, when communications is interrupted, when ESC key is pressed during communications, when all communications end and data transmission request-to-send run out, resume STANDBY screen.



NOTE

It is optional service to download and analyze log data, and exclusive jigs are necessary. As for details, refer to 7-3 and contact RIKEN KEIKI.

7

Maintenance

7-1. Maintenance intervals and items

There are two types of maintenance to be performed by the user, "daily maintenance" and "monthly regular maintenance" and one type of maintenance to be performed by RIKEN KEIKI service engineer, "biannual regular maintenance."

7-1-1. Daily maintenance

Daily maintenance is performed to check the soundness of the product operations. Perform daily maintenance according to the maintenance items and criteria shown in the table below.

Maintenance item	Criteria
① POWER lamp	In a normal state, the POWER lamp remains ON at all times. Check that the light remains ON normally.
② Lamp1, Lamp2, and Lamp3	In a normal state, the Lamp1, Lamp2, and Lamp3 remain OFF at all times. Check that these lamps remain OFF.
③ LCD display	Check that the LCD does not display FAILURE, OUT OF SPECIFICATION, MAINTENANCE REQUIRED etc.
④ Reference gas (REF) and measuring gas (GAS) flow rates	Check that the black circles that indicate the reference gas (REF) and measuring gas (GAS) flow rates stay between the two solid lines that represent the upper and lower limits.

If some kind of abnormal state is found, perform investigation and maintenance according to the troubleshooting procedures.

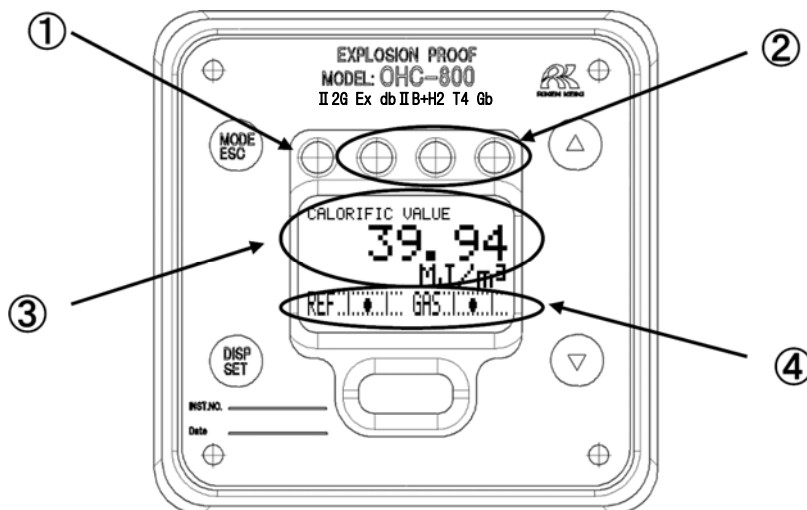

7-1-2. Monthly regular maintenance

Monthly regular maintenance is performed to check the soundness of the exposition-proof performance. Perform monthly regular maintenance according to the maintenance items and criteria shown in the table below.

Maintenance item	Criteria
① Casting enclosure	Is there any abnormality or damage on the enclosure?
② Clamping screws and bolts	Is there any abnormality such as looseness or loss of clamping screws and bolts?
③ Explosion-proof certification nameplate	Is there any abnormality on the nameplate on which a model examination certificate mark is printed?
④ Transparent window	Is there any crack, discoloration, or deformation on the transparent window?
⑤ Grounding terminal	Is there normal wire connection to the grounding terminal?
⑥ Cable gland wiring	Is there any abnormality on the cable gland or wiring?

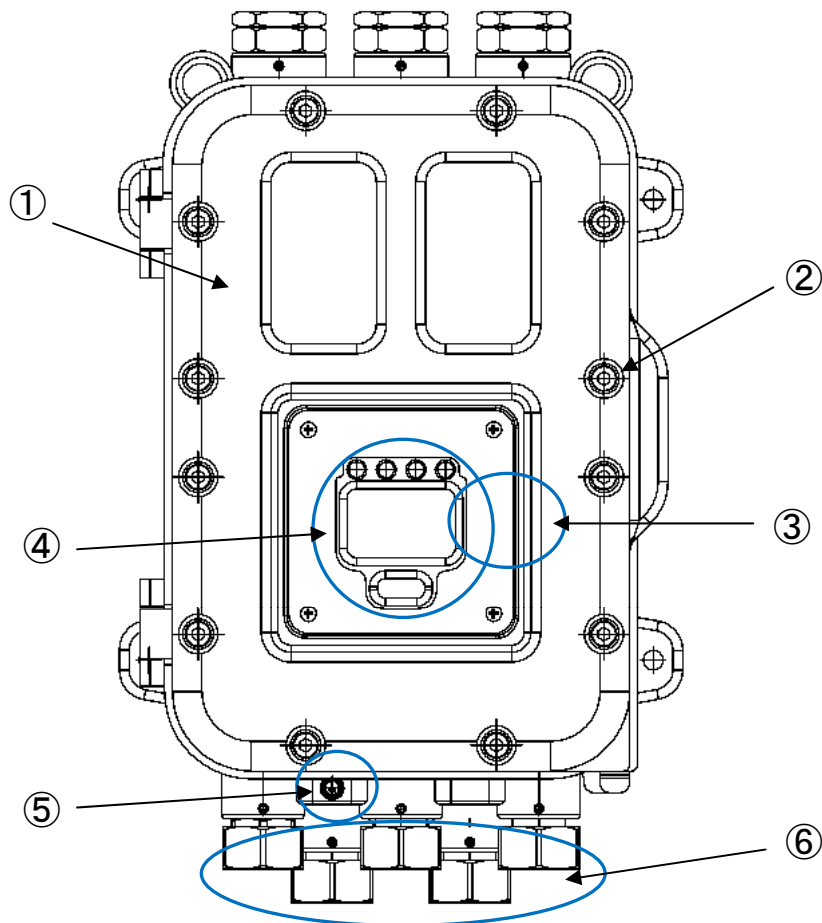

7-1-3. Biannual regular maintenance

Biannual regular maintenance is performed to check the soundness of the sensor output, power voltage, contact output, analog signal output etc. As required, perform the items shown below.

- | | |
|--|-----------------------------|
| (1) Device cleaning | (2) Parts replacement |
| (3) External tubing parts replacement | (4) Reading operation check |
| (5) Log data analysis (optional service) | (6) Others |

At the biannual regular maintenance, the items of daily maintenance and monthly regular maintenance are also checked.

NOTE

Log data analysis (optional service)

The OHC-800, having an advanced self-monitoring/diagnostic function, monitors the soundness of the items shown below at all times.

- | | |
|---|------------------------------|
| • Light source brightness | • Various fault flag |
| • Contrast | • Sensor voltage |
| • Unit temperatures | • 4 - 20 mA output state |
| • GAS OUT absolute pressure fluctuation | • Optical sensor unit output |
| • GAS flow rate | • Sonic sensor unit output |
| • REF flow rate | |

The product stores at all times the log data that records the "operation statuses" and "diagnostic results" for more than one year in the past.

In "log data analysis," an optional service, RIKEN KEIKI service engineer collects this log data via IrDA communications, and RIKEN KEIKI analyzes the data, graph the "operation statuses" and "self-diagnostic results" for the past one year, and submits a report about them.

The analysis results available in this service, based on long-term data over the past one year, can be used as effective data by the user to check the stability of devices throughout the year and evaluate the plant operation statuses, which cannot be easily done in ordinary biannual regular maintenance. If you are considering the use of this service, contact RIKEN KEIKI.

7-2. Recommended regular replacement parts

OHC-800

Average ambient temperature	Recommended regular replacement parts	Replacement intervals
Less than 50°C	None	—
50°C or more	Power terminal unit	5 years

This product has a design lifetime of 10 years.

The filters etc. used in the sampling device and its surroundings must be replaced as needed.

8

Storage, Relocation, and Disposal

8-1. Procedures to store the calorimeter or leave it for a long time

To leave the OHC-800 and sampling device unused for a middle or long term without removing tubing or cables, it is sufficient to stop supplying the power and measuring and reference gases. To store them in a warehouse etc. for a long term after removing the tubing and cables, it is necessary to store them at normal temperatures and humidities where they are not exposed to direct sunlight. In either case, keep the front and other lids of the OHC-800 enclosure closed so that the explosion-proof joint surface is not damaged.

8-2. Procedures to relocate the calorimeter or use it again

To resume using the calorimeter after reconnecting the tubing and cables, request RIKEN KEIKI to start up the device. When the procedure involves only the resupply of the power and measuring and reference gases, contact RIKEN KEIKI if required.



CAUTION

When the OHC-800 is relocated, perform external output 4-20mA according to “6.2.4 4-20mA output adjustment” in connecting the upper system.

8-3. Disposal of products

When the OHC-800 is disposed of, it must be treated properly as an industrial waste in accordance with the local regulations and other requirements.

Before disposing of the OHC-800, remove the following coin-type battery installed in it.

Specifications of coin-type lithium manganese dioxide battery

Product name: CR1220

Nominal voltage: 3 V

Standard capacity: 36 mAh

Removal procedure

Remove the main controller unit. The battery is located in the back of the unit as shown in the figure on the right. A resin case covers the battery. Since the resin case is bonded to the PCB, remove it using a pair of pliers, flat-blade screwdriver etc. Slide the battery sideways to remove it. Dispose of the removed battery after wrapping insulating tape around it.

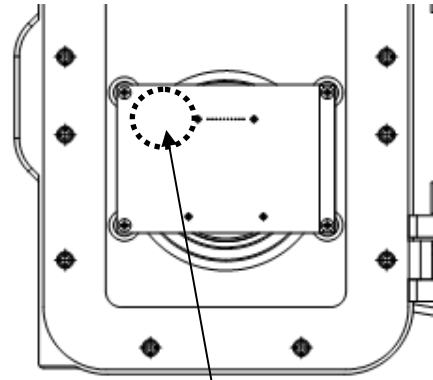

Located on the back of this location

9







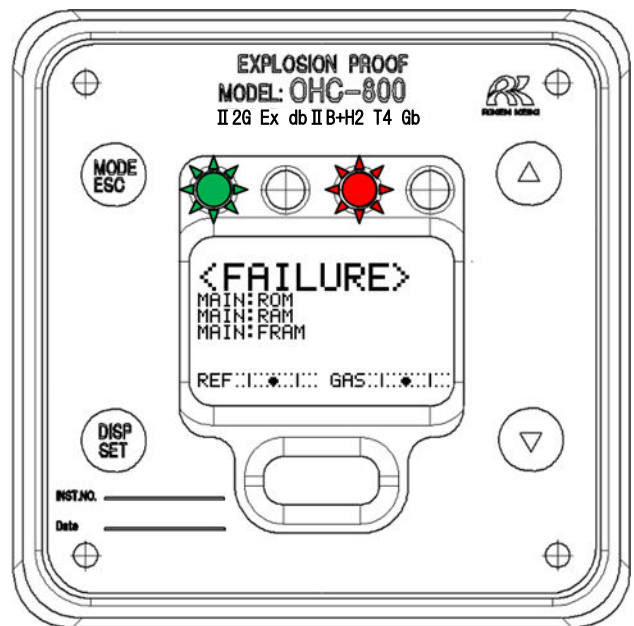

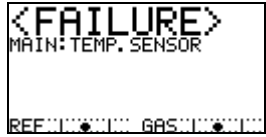

Troubleshooting

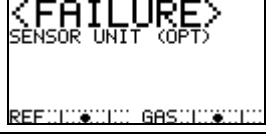
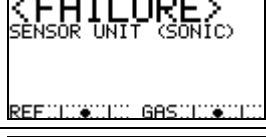





The information in this chapter is provided to help identify the state of the product from the display on the OHC-800 and trace down the cause of a trouble etc. This chapter does not describe all the symptoms that may be encountered although efforts are made to include as many symptoms as possible. If the cause cannot be identified using the information in this chapter, contact RIKEN KEIKI.

9-1. <FAILURE>

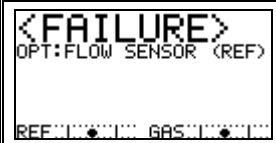
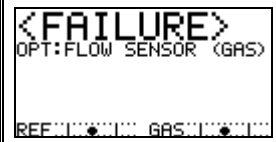

Display	State explanation	Main cause and required action
	Main controller: ROM abnormality	An abnormality in the main controller ROM. The main controller must be replaced.
	Main controller: RAM abnormality	An abnormality in the main controller RAM. The main controller must be replaced.
	Main controller: FRAM abnormality	An abnormality in the main controller FRAM. The main controller must be replaced.



Display	State explanation	Main cause and required action
	Main controller: Abnormal temperature detected	Unless an abnormality is found in the installation environment, a malfunction of the main controller is suspected.
	Main controller: Supply power abnormality detected	Unless an abnormality is found in the OHC-800 supply power, a malfunction of the power terminal unit or main controller is suspected.
	Main controller: Optical sensor unit abnormality detected	A malfunction of the connecting cable between the main controller and the optical sensor unit or the optical sensor unit is suspected.
	Main controller: Sonic sensor unit abnormality detected	A malfunction of the connecting cable between the main controller and the sonic sensor unit or the sonic sensor unit is suspected.
	Main controller: 4 - 20 mA output signal abnormality detected	Unless an abnormality such as a break in 4 - 20 mA cable is found, a malfunction of the power terminal unit or main controller is suspected.
	Optical sensor unit: ROM abnormality detected	An abnormality in the optical sensor unit ROM. The optical sensor unit must be replaced.
	Optical sensor unit: RAM abnormality detected	An abnormality in the optical sensor unit RAM. The optical sensor unit must be replaced.
	Optical sensor unit: FRAM abnormality detected	An abnormality in the optical sensor unit FRAM. The optical sensor unit must be replaced.
	Optical sensor unit: Temperature abnormality detected	Unless an abnormality is found in the installation environment, a malfunction of the optical sensor unit is suspected.
	Optical sensor unit: GAS OUT abnormal absolute pressure detected	Unless an abnormality in the GAS OUT exhaust environment or tubing such as clogging is found, a malfunction of the optical sensor unit is suspected.
	Optical sensor unit: Supply power abnormality detected	Unless an abnormality is found in the OHC-800 supply power, a malfunction of the power terminal unit or optical sensor unit is suspected.
	Optical sensor unit: Abnormally low brightness of interference fringe image data detected	A damage of the optical sensor unit due to inhalation of foreign substances or waste materials is suspected.

Display	State explanation	Main cause and required action
	Optical sensor unit: Abnormally low contrast of interference fringe image data detected	A damage of the optical sensor unit due to inhalation of foreign substances or waste materials is suspected.
	Optical sensor unit: Reference gas flow rate abnormality detected	Unless a significantly low or high supply volume is found, clogging or leak of a flow path in and out of the product is suspected.
	Optical sensor unit: Measuring gas flow rate abnormality detected	Unless a significantly low or high supply volume is found, clogging or leak of a flow path in and out of the product is suspected.
	Optical sensor unit: Out-of-detection-range measuring gas detected	Unless an abnormality in the composition of the measuring gas is found, a malfunction of the optical sensor unit is suspected.
	Sonic sensor unit: Measuring sound pressure abnormality detected	A damage of the sonic sensor unit due to inhalation of foreign substances or waste materials is suspected.
	Sonic sensor unit: ROM abnormality detected	An abnormality in the sonic sensor unit ROM. The sonic sensor unit must be replaced.
	Sonic sensor unit: RAM abnormality detected	An abnormality in the sonic sensor unit RAM. The sonic sensor unit must be replaced.
	Sonic sensor unit: EEP-ROM abnormality detected	An abnormality in the sonic sensor unit EEP-ROM. The sonic sensor unit must be replaced.

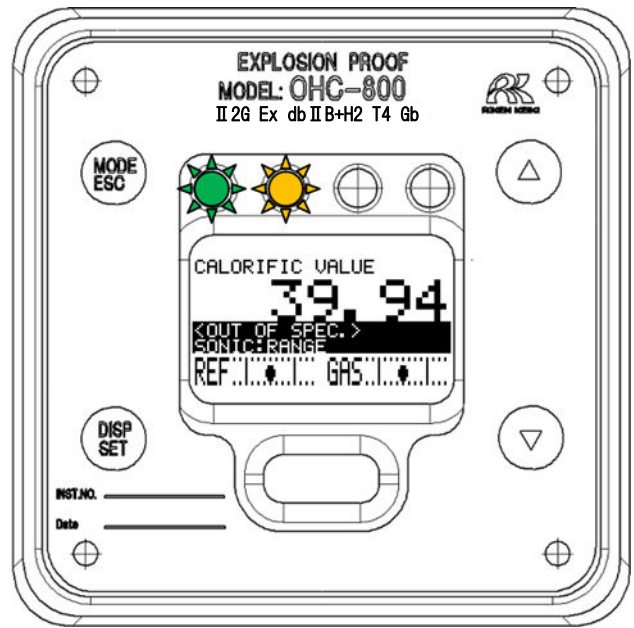
9-2. <OUT OF SPECIFICATION>

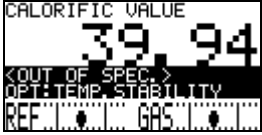
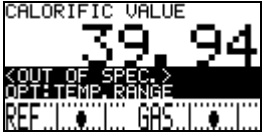
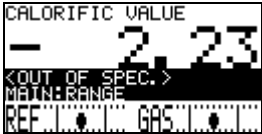
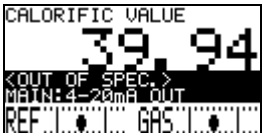

Display	State explanation	Main cause and required action
	Sonic sensor unit: Out-of-measurement-range measuring gas detected	Check that the conditions specified in the "Measuring gas specification sheet" are met.
	Sonic sensor unit: Out-of-specification temperature detected	Reconsider the operating environment.
	Optical sensor unit: Out-of-measurement-range measuring gas detected	Check that the conditions specified in the "Measuring gas specification sheet" are met.
	Optical sensor unit: Out-of-defined-range reference gas flow rate detected	Adjust the reference gas flow rate so that the black circle comes between the two solid lines that represent the upper and lower limits.
	Optical sensor unit: Out-of-defined-range measuring gas flow rate detected	Adjust the measuring gas flow rate so that the black circle comes between the two solid lines that represent the upper and lower limits.
	Optical sensor unit: Sudden change in GAS OUT absolute pressure detected	Reconsider the GAS OUT exhaust destination or the GAS OUT diffusion structure.
	Optical sensor unit: Out-of-measurement-range GAS OUT absolute pressure detected	Check the absolute pressure of the GAS OUT exhaust line and the GAS OUT tubing for abnormality.

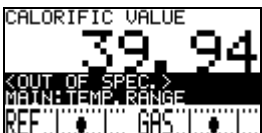
Display	State explanation	Main cause and required action
	Optical sensor unit: Sudden temperature change detected	Reconsider the operating environment.
	Optical sensor unit: Out-of-specification temperature detected	Reconsider the operating environment.
	Out-of-specification Opt-Sonic: Calculation results Calorific value and density (specific gravity) detected	Check that the conditions specified in the "Measuring gas specification sheet" are met.
	Main controller: 4 - 20 mA signal output failure detected	Check that the use method meets the wire connection method and load resistance (300 Ω at the maximum) conditions.
	Main controller: Out-of-specification power supply detected	Check whether the power supplied to the OHC-800 meets the required specifications.
	Main controller: Out-of-specification temperature detected	Reconsider the operating environment.

9-3. <MAINTENANCE REQUIRED>

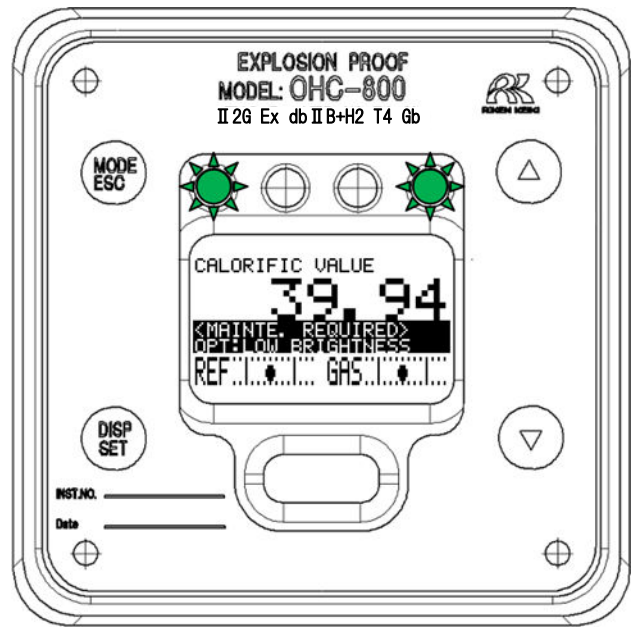





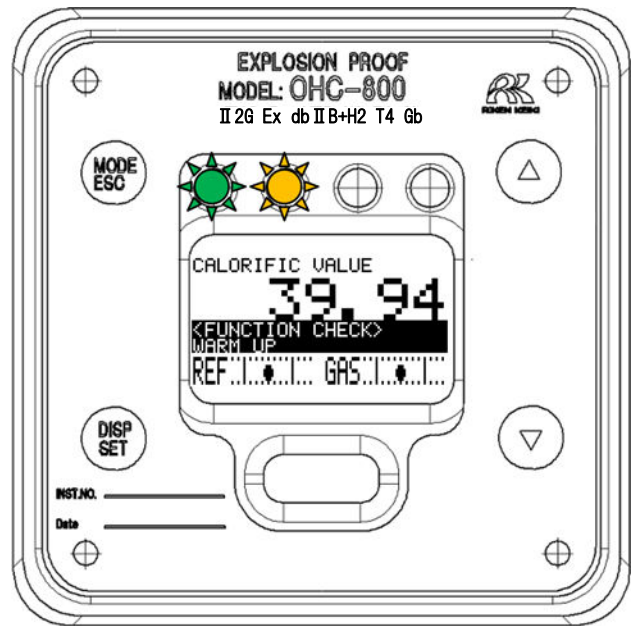

Display	State explanation	Main cause and required action
	Sonic sensor unit: Detected low sound pressure within permissible range	The sonic sensor contamination or deterioration has progressed. The sonic sensor unit must be replaced.
	Optical sensor unit: Detected drifting within permissible range	In SETUP MODE, perform reference calibration.
	Optical sensor unit: Detected low contrast of interference fringes within permissible range	The optical sensor contamination or deterioration has progressed. The optical sensor unit must be replaced.
	Optical sensor unit: Detected low brightness of interference fringes within permissible range	The optical sensor contamination or deterioration has progressed. The optical sensor unit must be replaced.
	Detected failure of sensor unit disabled due to calculation conditions of calorific value or density	Since other devices may be adversely influenced, it is recommended to investigate the cause and perform required action for it.
	Main controller: Indicates that the factory adjustment is not completed.	Not displayed for a shipped product ordinarily.



9-4. <FUNCTION CHECK>

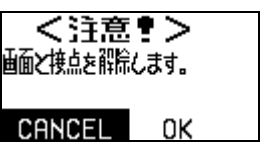

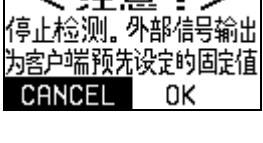
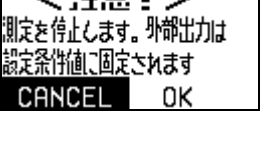
Display	State explanation	Main cause and required action
	Function check operation in progress via external communications	This display does not occur with ordinary specifications.
	Currently in SETUP MODE	---
	Automatic reference calibration (optional function) being performed	This display does not occur with ordinary specifications.
	Warm-up in progress	If the calorimeter is restarted, it enters 15-minute warm-up state.

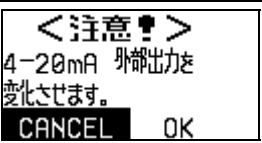
9-5. CAUTION screen

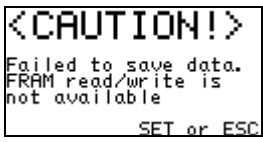
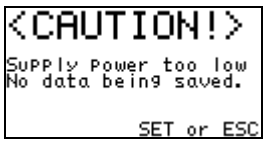
Display			Main cause and required action
English	Chinese	Japanese	
			Displayed before the LCD screen and contacts are unlatched.
			When entering the SETUP MODE, this screen is displayed before the measurement is stopped and 4 - 20 mA is fixed to the specified output value.
			This screen is displayed in the SETUP MODE when a signal output different from the specified value is requested.

Display	Main cause and required action
	When "Reference calibration" described in Section 6.2.6 is performed in the SETUP MODE, this screen is displayed upon the detection of data greatly different from the last result. A sufficient amount of reference gas may not be supplied from GAS IN of the OHC-800. Check the operations and procedures thoroughly for correctness, and select "OK." If this screen is frequently displayed, a malfunction of the optical sensor unit or sampling device is suspected.
	When the settings are changed in the SETUP MODE, this screen is displayed upon a failure in writing the setting information to FRAM. If a write failure occurs repetitiously or frequently, a malfunction of the main controller is suspected.
	When the settings are changed in the SETUP MODE, this screen is displayed upon a failure to supply the power required to write the setting information to FRAM. Unless an abnormality is found in the power supply to the OHC-800, a malfunction of the power terminal unit or main controller is suspected.
	This screen is displayed only under special work conditions such as those in the manufacturing process of the OHC-800.

9-6. Others

Display	Main cause and required action
	<p>When you are prompted to enter a password when switching to the SETUP MODE, entering an incorrect password causes the screen on the left to be displayed.</p> <p>Press the SET or ESC key to repeat the operation to enter the SETUP MODE.</p>

9-7. If not applicable to display

Display	Main cause	Required action
The power cannot be turned on. Nothing is displayed.	Power switch is turned off	Turn ON the power switch.
	The fuse has blown out	Check the fuse, if it has blown out, replace it with the rated fuse.
	Abnormalities/momentary blackout of power supply system	Check the power supply voltage. Provide the rated voltage. Take measures such as checking or adding the UPS, power supply line filter and insulation transformer.
	Internal connection cable abnormalities (open circuit/not connected/short circuit)	Check for a condition of the internal cable pulls out/clashed/broken/short circuit. If there is an abnormality on the flat-cable, replacement of the main unit is required, please contact RIKEN KEIKI. If there is an abnormality on the cable connected with the terminal, retry the wire connection.
	External connection cable abnormalities (open circuit/not connected/short circuit)	Check for a condition of the external cable pulls out/clashed/broken/short circuit. If there is an abnormality on the cable, replace the cable.

10

Product Specifications

10-1. Product specifications

Specification

Model:	OHC-800
Measuring principle:	Opt-Sonic calculation through measurement of refractive index and sound speed
Measuring gas:	See "Measuring gas specification sheet" attached.
Measuring targets:	Calorific value, density (specific gravity), and WOBBE index
Measuring range:	See "Measuring gas specification sheet" attached.
Measuring method:	Constant-flow-rate gas introduction using external sampling devices
Self-monitoring/diagnostic function:	Status monitoring using four classification categories <ul style="list-style-type: none"> • FAILURE • FUNCTION CHECK • MAINTENANCE REQUIRED • OUT OF SPECIFICATION
Display:	Full-dot LCD (with backlight) Lamps Green: Lights up at power on. Orange: Lights up in conjunction with Contact Output 1. Red: Lights up in conjunction with Contact Output 2. Green: Lights up in conjunction with Contact Output 3.
External Output 1:	4 - 20 mA DC (insulated, source current type) maximum load resistance of 300 Ω, minimum resolution under 0.01 mA
External Output 2:	RS-485 (MODBUS) communication function
External Output 3:	IrDA communication output (for maintenance)
Contact Output 1:	Activated if the FUNCTION CHECK or OUT OF SPECIFICATION condition is met.* [No-voltage contact, contact capacity of 2 A, 30 VDC (resistance load)]
Contact Output 2:	Activated if the FAILURE condition is met.* [No-voltage contact, contact capacity of 2 A, 30 VDC (resistance load)]
Contact Output 3:	Activated if the MAINTENANCE REQUIRED condition is met.* [SSR contact, contact capacity of 20 W, 240 VAC (resistance load)]
How to operate:	Operation using a magnet control key (The calorimeter can be operated while maintaining the explosion-proof performance.)
Power supply:	100 - 240 VAC ±10%, 50/60 Hz, max. 18 VA or 24 VDC ±10%, max. 5 W (The setting can be changed to either the AC or DC specifications.)
Protection class:	Equivalent to IP66 or IP67
Ambient temperature:	-20 to +57°C(Japanese explosion-proof spec.) -20 to +60°C(Overseas explosion-proof spec.)

Ambient humidity:	95%RH or less
Measuring gas temperature:	Same as ambient temperature
Outer dimensions:	Approx. 286 (W) x 453 (H) x 150 (D) mm
Weight:	Approx. 23 kg
Explosion-proof structure:	Flame-proof enclosures (Explosion-proof class: Ex d II B+H2 T4) TC20344 (Japanese explosion-proof spec.) Flame-proof enclosures (Explosion-proof class: II 2GExdb II B+H2 T4Gb) DEKRA12ATEX0187x (Overseas explosion-proof spec.)

* The operating conditions of contacts can be changed.
* Specifications subject to changes without notice.

10-2. Principle of this product

10-2-1. Opt-Sonic calculation (calorific value)

Figure 1 is a graph that shows the correlation between the calorific value of pure gases and sound speed. The straight line drawn in this figure represents the function Q_{Sonic} that connects the points of paraffinic hydrocarbon gases.

Figure 2 is a graph that shows the correlation between the calorific value of pure gases and refractive index. The straight line drawn in this figure represents the function Q_{Opt} that connects the points of paraffinic hydrocarbon gases.

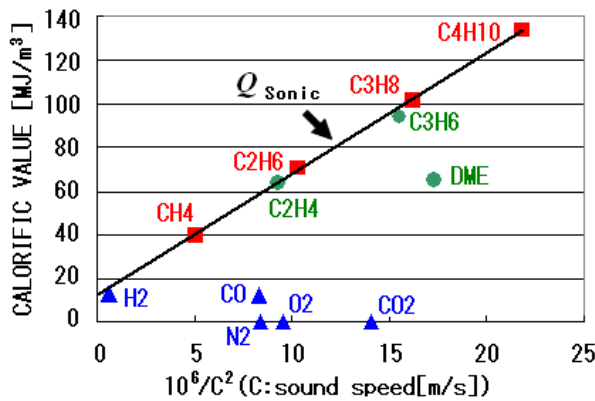

Figure 1: Correlation between calorific value and sound speed

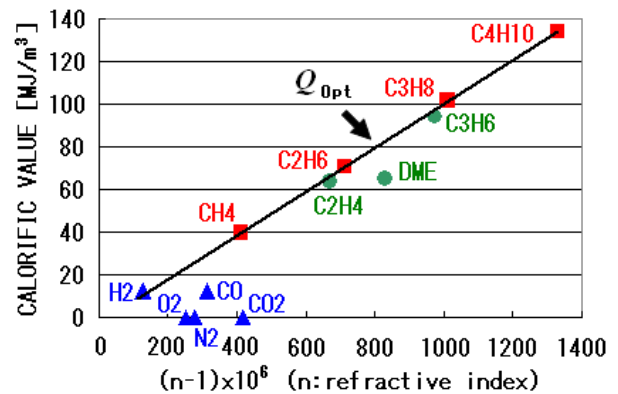

Figure 2: Correlation between calorific value and refractive index

If the gas to be measured consists only of paraffinic hydrocarbon gases, an accurate calorific value can be obtained by measuring sound speed and refractive index and substituting them into the functions Q_{Sonic} and Q_{Opt} .

However, if the gas to be measured includes components with sound speed and refractive index that are not on the straight lines drawn by the functions Q_{Sonic} and Q_{Opt} , respectively, i.e., N₂, O₂, CO₂, CO etc., these components act as interference gases that generate errors.

The correlation between the true calorific value of the measuring gas Q and the functions Q_{Sonic} and Q_{Opt} can be expressed by the following formulas (1) and (2).

$$Q = Q_{Opt} - \sum k_i \cdot x_i \tag{1}$$

$$Q = Q_{Sonic} - \sum k'_i \cdot x_i \tag{2}$$

where x_i represents the volume fraction of interference gas component i , and k_i and k'_i represent the error coefficients caused by interference gas component i .

The error coefficients k_i and k'_i represent the "distances" in a vertical axis direction from the component i to the straight lines drawn by the functions Q_{Sonic} and Q_{Opt} in the graphs shown in Figures 1 and 2.

RIKEN KEIKI has discovered a correlation in which the ratio of k_i to k'_i is approximately constant, regardless of the types of interference gases.

$$k'_i \approx \alpha \cdot k_i \tag{3}$$

Using the relational formula (3), the formula (2) can be written as follows:

$$Q \approx Q_{Sonic} - \alpha \cdot \sum k_i \cdot x_i \tag{4}$$

The formulas (1) and (4) can be used to derive the relational formula of the Opt-Sonic calculation for obtaining calorific value.

$$Q \approx Q_{Opt} - \frac{Q_{Opt} - Q_{Sonic}}{1 - \alpha} \tag{5}$$

Figure 3 shows the correlation between the Opt-Sonic calculation and calorific value. Not only the paraffinic hydrocarbon gases but also the components N₂, O₂, CO₂, and CO are on one straight line, demonstrating that the influences of interference gases have been effectively removed.

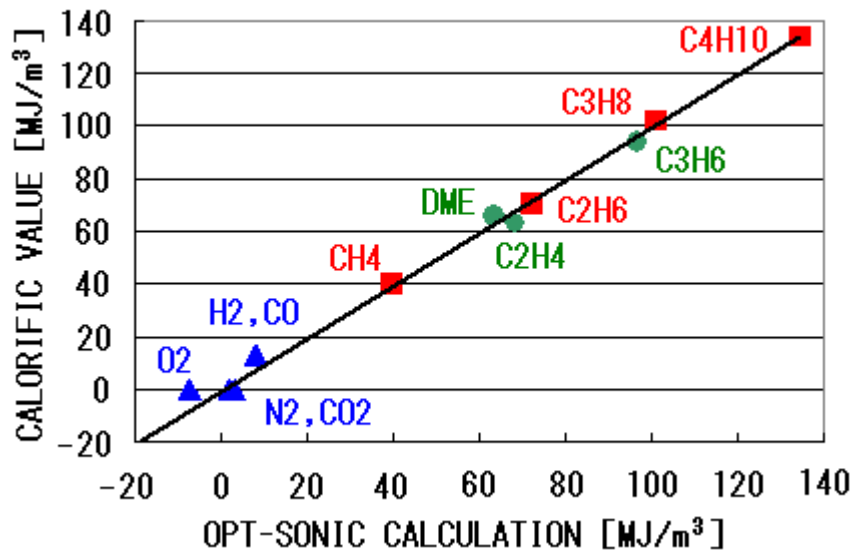

Figure 3: Correlation between Opt-Sonic calculation and calorific value

10-2-2. Opt-Sonic calculation (specific gravity)

Figure 4 is a graph that shows the correlation between the specific gravity of pure gases and sound speed. The straight line drawn in this figure represents the function d_{Sonic} that connects the points of paraffinic hydrocarbon gases.

Figure 5 is a graph that shows the correlation between the specific gravity of pure gases and refractive index. The straight line drawn in this figure represents the function d_{Opt} that connects the points of paraffinic hydrocarbon gases.

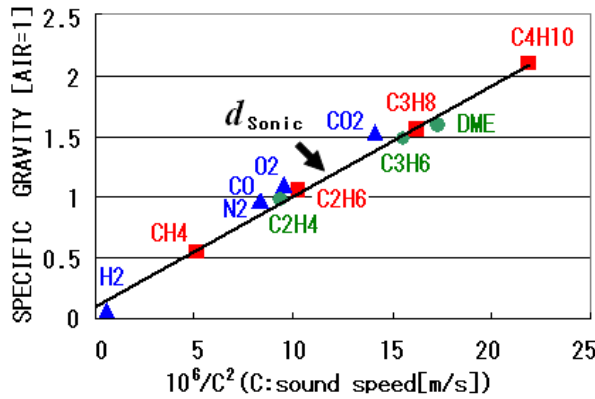

Figure 4: Correlation between specific gravity and sound speed

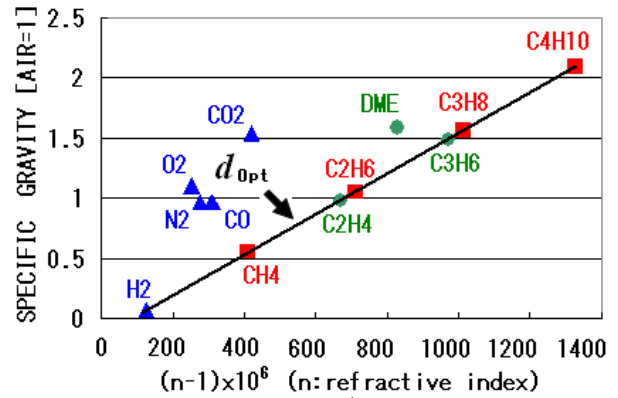

Figure 5: Correlation between specific gravity and refractive index

If the gas to be measured consists only of paraffinic hydrocarbon gases, an accurate specific gravity can be obtained by measuring sound speed and refractive index and substituting them into the functions d_{Sonic} and d_{Opt} .

However, if the gas to be measured includes components with sound speed and refractive index that are not on the straight lines drawn by the functions d_{Sonic} and d_{Opt} , respectively, i.e., N₂, O₂, CO₂, CO etc., these components act as interference gases that generate errors.

The correlation between the true specific gravity of the measuring gas d and the functions d_{Sonic} and d_{Opt} can be expressed by the following formulas (6) and (7).

$$d = d_{Opt} - \sum k_i \cdot x_i \tag{6}$$

$$d = d_{Sonic} - \sum k'_i \cdot x_i \tag{7}$$

where x_i represents the volume fraction of interference gas component i , and k_i and k'_i represent the error coefficients caused by interference gas component i .

The error coefficients k_i and k'_i represent the "distances" in a vertical axis direction from the component i to the straight lines drawn by the functions d_{Sonic} and d_{Opt} in the graphs shown in Figures 4 and 5.

RIKEN KEIKI has discovered a correlation in which the ratio of k_i to k'_i is approximately constant, regardless of the types of interference gases.

$$\beta \cdot k'_i \approx k_i \tag{8}$$

Using the relational formula (8), the formula (6) can be written as follows:

$$d \approx d_{Opt} - \beta \cdot \sum k'_i \cdot x_i \tag{9}$$

The formulas (7) and (9) can be used to derive the relational formula of the Opt-Sonic calculation for obtaining specific gravity.

$$d \approx d_{\text{Sonic}} - \frac{d_{\text{Sonic}} - d_{\text{Opt}}}{1 - \beta} \tag{10}$$

Figure 6 shows the correlation between the Opt-Sonic calculation and specific gravity. Not only the paraffinic hydrocarbon gases but also the components N₂, O₂, CO₂, and CO are on one straight line, demonstrating that the influences of interference gases have been effectively removed.

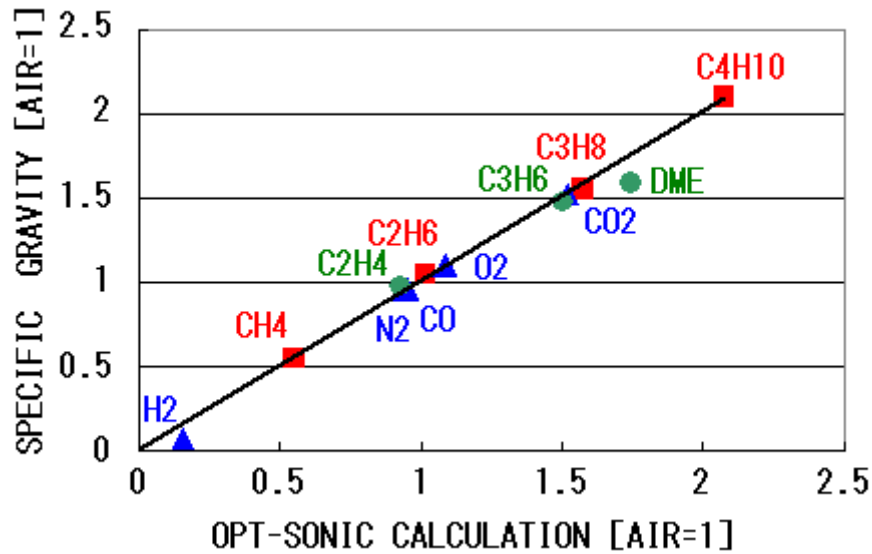
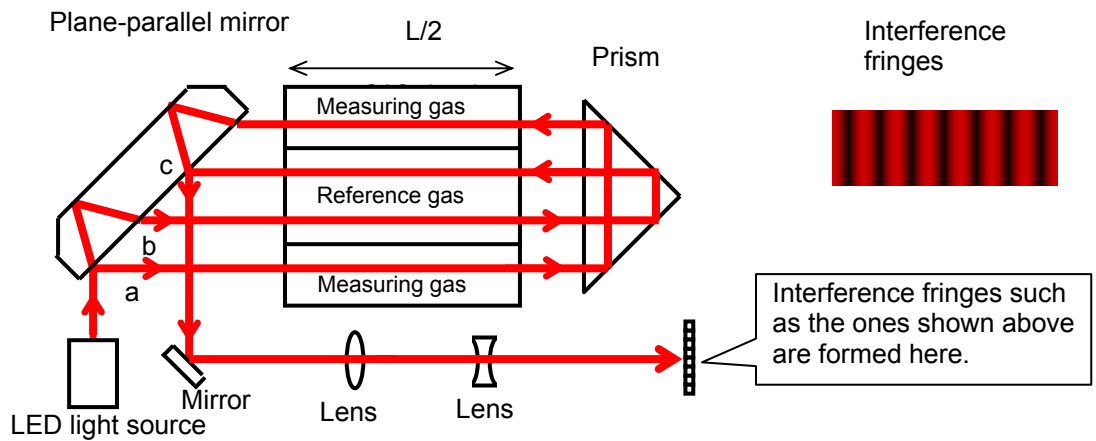

Figure 6: Correlation between Opt-Sonic calculation and specific gravity

10-2-3. Principle of optical sensor



A schematic diagram of the interferometer used in the optical sensor is shown above. This interferometer forms "interference fringes" that move in proportion to the "differences of refractive index" between the measuring and reference gases.

The movement distance of interference fringes $\Delta\theta$ can be expressed as the following formula:

$$\Delta\theta = \frac{2\pi L(n_{GAS} - n_{REF})}{\lambda}$$

- L : Chamber length
- n_{GAS} : Refractive index of measuring gas
- n_{REF} : Refractive index of reference gas
- λ : Light source wavelength

The light source wavelength and chamber length are physically quite stable. Therefore, the refractive index of measuring gas n_{GAS} can be accurately obtained by measuring the movement distance of interference fringes.

10-2-4. Principle of sonic sensor

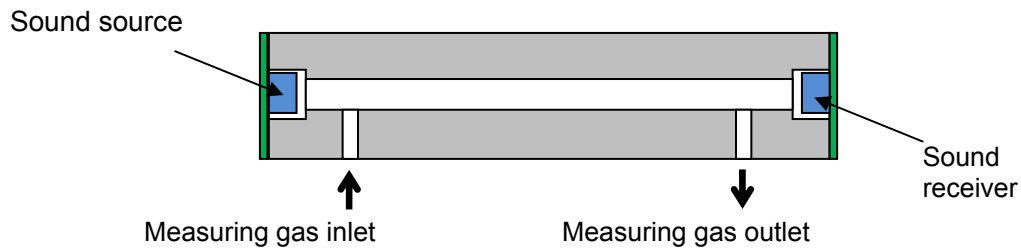

A schematic diagram of the sonic sensor is shown above. This sensor emits a sound from the sound source into a tube in which a measuring gas flows and then measures the time τ in which the sound travels through the measuring gas and arrives at the sound receiver.

The speed of sound that travels through the measuring gas v_{GAS} can be expressed as the following formula:

$$v_{GAS} = \frac{L}{\tau}$$

L : Distance from the sound wave source to the sound receiver

τ : Time in which a sound from the sound source arrives at the sound receiver

The distance from the sound source to the sound receiver L is physically quite stable. Therefore, the speed at which a sound travels through the measuring gas v_{GAS} can be accurately obtained by measuring the sound travel time τ .

11

Definition of Terms

11-1. Definition of terms used in operating manual

Measuring gas	Gas used to measure calorific value, density, and WOBBE index on this product.
Refractive index	One of the indexes for how the light travels through a substance. This value is obtained by dividing the speed of light that travels through a vacuum by the speed of light that travels through a substance.
Reference gas	Gas used on an optical sensor unit as a reference for measuring the refractive index of a measuring gas. The gas type varies depending on the product specifications.
Reference gas calibration (REF CAL.)	Operation for adjusting the reading when measuring the reference gas concentration.
Opt-Sonic calculation	This proprietary technology developed by RIKEN KEIKI in 2007 and 2010 refers to calculating the "calorific value" and "density" of a fuel gas with high accuracy by measuring the speeds of "light" and "sound" that travel through the fuel gas and eliminating the influence of interference gases such as N ₂ , CO ₂ , CO, and O ₂ through calculation.
Calculation Factor α	Coefficient that is set to eliminate the influence of interference gases when calculating "calorific value" in Opt-Sonic calculation. This value is determined by the major fluctuating components of interference gases in the fuel gas.
Calculation Factor β	Coefficient that is set to eliminate the influence of interference gases when calculating "density" in Opt-Sonic calculation. This value is determined by the major fluctuating components of interference gases in the fuel gas.

11-2. Definition of terms used in "Measuring gas specification sheet"

Instrument air	Dry, clean air. Use Classes 1.1.1 to 1.6.2 stipulated in JIS B8392-1:2003 (ISO 8573-1:2001). In cold climates, use Classes 1.1.1 to 1.3.2.
MJ/m ³	Calorific value per cubic meter expressed in SI units.
Gross (HHV, SCV)	All of these terms are synonymous, which are abbreviations for Gross calorific value (Gross), Higher Heating Value (HHV) and Superior Calorific Value (SCV). This calorific value includes "latent heat" obtained when water vapor generated during combustion is compressed.
Net (LHV, ICV)	All of these terms are synonymous, which are abbreviations for Net calorific value (Net), Lower Heating Value (LHV) and Inferior Calorific Value (ICV). This calorific value does not include "latent heat" obtained when water vapor generated during combustion is compressed.
Standard temperature	Temperature of a gas to be used as a reference for measuring and displaying calorific value and density in units per unit volume.
Standard pressure	Pressure of a gas to be used as a reference for measuring and displaying calorific value and density in units per unit volume.
kg/m ³	Mass per cubic meter expressed in SI units.
Specific gravity [AIR = 1]	Value obtained by dividing the density of a certain substance by that of a reference substance. To obtain the specific gravity of a gas, it is a common practice to use air as the reference. The OHC-800 also derives a specific gravity using air as the reference.
WOBBE index	The WOBBE index (W.I.) is one of the combustion quality indexes. This value is obtained by dividing a calorific value by the square root of a specific gravity. This value is in proportion to the calorific value released per unit of time when a gas is supplied under a certain pressure to a nozzle with a certain orifice.

Declaration of Conformity

We, **RIKEN KEIKI CO., LTD.**

2-7-6, Azusawa, Itabashi-ku,
Tokyo 174-8744 Japan

declare in our sole responsibility that the following product conforms to all the relevant provisions.

Product Name	:	Calorimeter
Model Name	:	OHC-800
Council Directives	:	EMC : 2014/30/EU
		ATEX : 2014/34/EU
		RoHS : 2011/65/EU
Applicable Standards	:	EMC : EN 61000-6-2:2005
		EN 61000-6-3:2007+A1:2011
		EN 61000-6-4:2007+A1:2011
		ATEX : EN 60079-0:2012+A11:2013
		EN 60079-1:2014
		RoHS : EN 50581(2012)
Name and address of the ATEX Notified Body	:	DEKRA Certification B.V (NB 0344) Meander 1051, 6825 MJ Arnhem P.O.Box 5185,6802 ED Arnhem The Netherlands
Number of the EU type examination certificate	:	DEKRA 12ATEX0187 X 25 April 2017
Name and address of the ATEX Auditing Organization	:	SGS Baseefa Ltd. (NB 1180) Rockhead Business Park Staden Lane SK17 9RZ BUXTON United Kingdom

The Marking of the equipment or protective system shall include the following : II 2G Ex db II B+H2 T4 Gb

Year to begin affixing CE Marking : 2017

Place: TOKYO, Japan

Signature: 
Full name: Tetsuya Kawabe

Date: May.16, 2017

Title: Director, Quality control center